

Dimensions (Unit:mm)

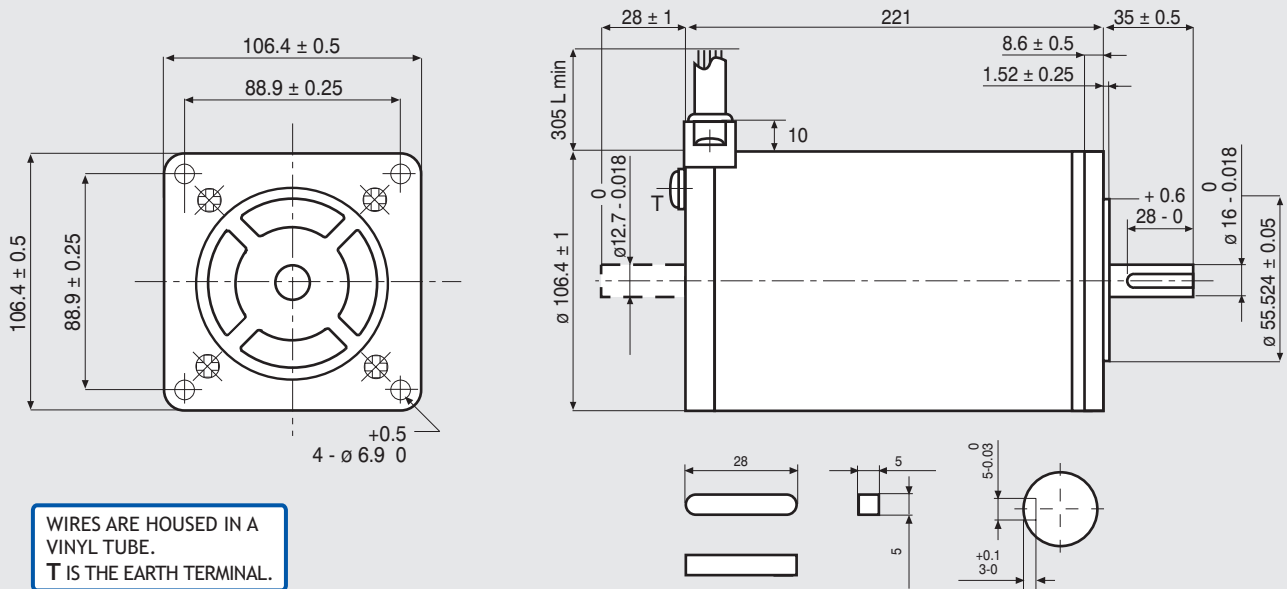

FEATURES

MODEL	103-H89223-6341 (103-H89223-6311)	
BASIC STEP ANGLE	1.8° ± 0.09°	
BIPOLAR CURRENT	(Amp)	6.0
UNIPOLAR CURRENT	(Amp)	
RESISTANCE	(Ohm)	0.63
INDUCTANCE	(mH)	8.0
BIPOLAR HOLDING TORQUE	(Ncm)	2460
UNIPOLAR HOLDING TORQUE	(Ncm)	
ROTOR INERTIA	(Kgm ² x 10 ⁻⁷)	22000
THEORETICAL ACCELERATION	(rad x sec. ⁻²)	11100
BACK E.M.F.	(V/Krpm)	410
MASS	(Kg)	10
PROTECTION DEGREE	IP43	
LEADS CODE	V	

Codes between brackets refer to double shaft models.
Le sigle fra parentesi si riferiscono ai modelli bialbero.

TORQUE/SPEED CURVE

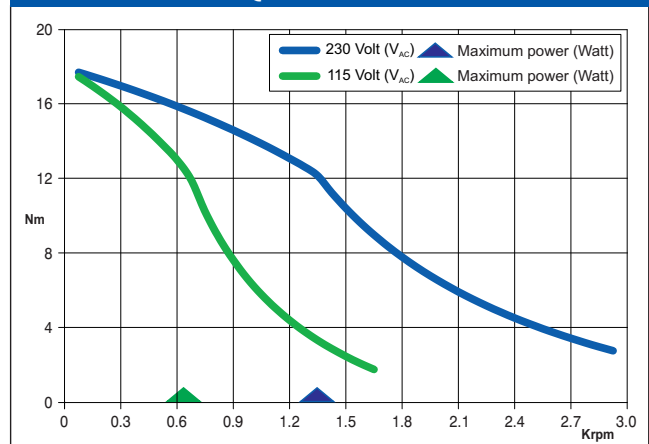

R.T.A. s.r.l. PAVIA (ITALY) SANYO DENKI CO., Ltd (JAPAN)



EMC - 10 - 14

Suggested R.T.A. driver: PLUS Series, X-MIND Series.