

Dimensions (Unit:mm)

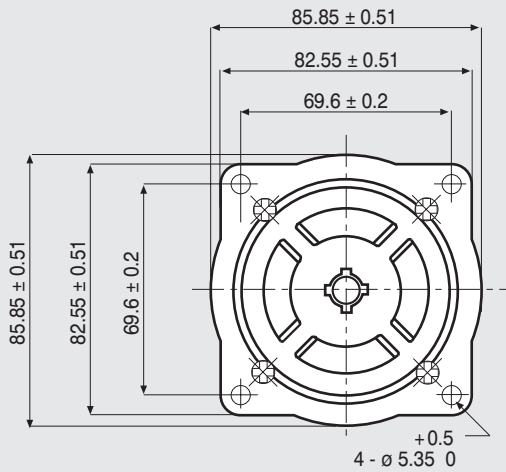

WIRES ARE HOUSED IN A VINYL TUBE.
T IS THE EARTH TERMINAL.

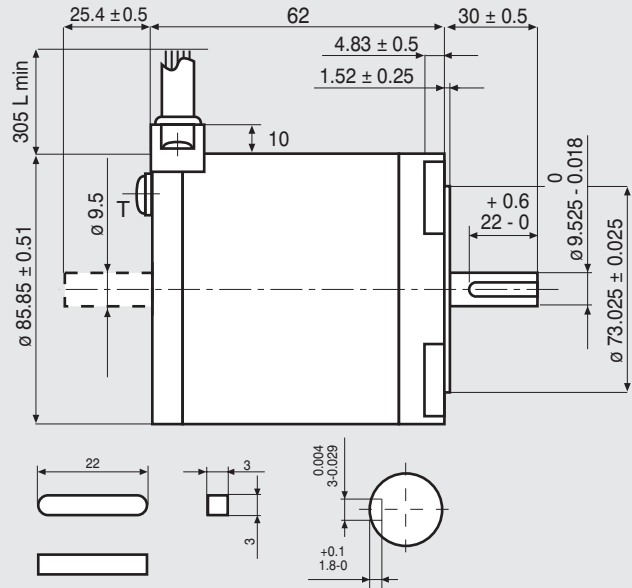

FEATURES

MODEL	103-H8221-6241 (103-H8221-6211)	
BASIC STEP ANGLE	1.8° ± 0.09°	
BIPOLAR CURRENT	(Amp)	6.0
UNIPOLAR CURRENT	(Amp)	
RESISTANCE	(Ohm)	0.3
INDUCTANCE	(mH)	1.65
BIPOLAR HOLDING TORQUE	(Ncm)	300
UNIPOLAR HOLDING TORQUE	(Ncm)	
ROTOR INERTIA	(Kgm ² x 10 ⁻⁷)	1450
THEORETICAL ACCELERATION	(rad x sec. ⁻²)	20600
BACK E.M.F.	(V/Krpm)	50
MASS	(Kg)	1.5
PROTECTION DEGREE		IP43
LEADS CODE		V

Codes between brackets refer to double shaft models.
Le sigle fra parentesi si riferiscono ai modelli bialbero.

TORQUE/SPEED CURVE

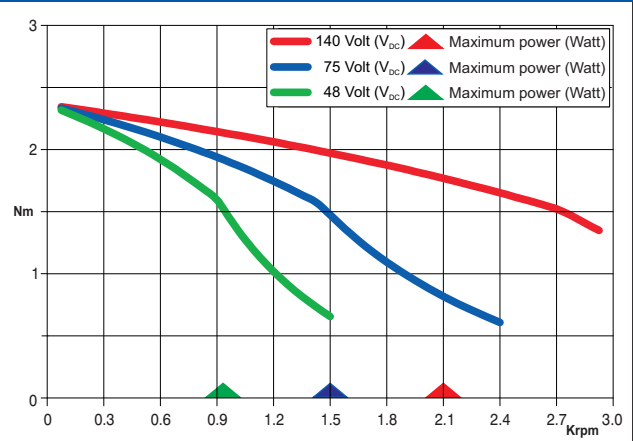

R.T.A. s.r.l. PAVIA (ITALY) SANYO DENKI CO., Ltd (JAPAN)



EMC - 10-14

Suggested R.T.A. driver: NDC/A-NDC Series, HGD Series, PLUS Series.