

alpha Basic Line

PLANETARY GEARBOXES CP / CPS

The planetary gearboxes of the alpha Basic Line are the ideal choice for cost-oriented solutions. These gearboxes further increase design freedom in machines due to new additional output variants as well as five different sizes.

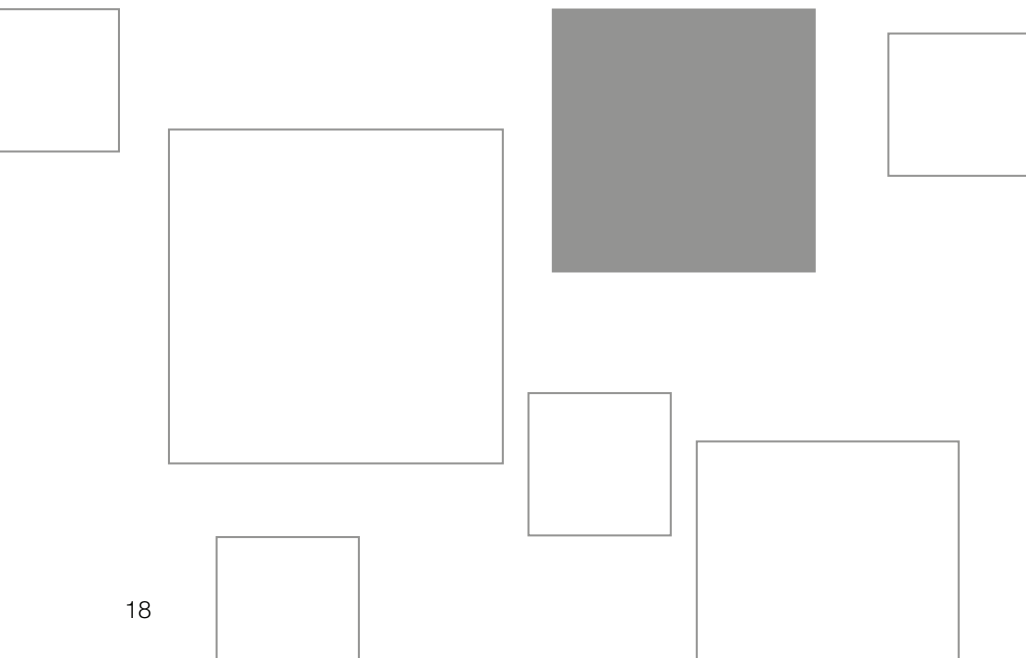



* CPS with replaceable B5 output flange

CP / CPS – Geared up to Fit

CP



Tailored to applications in the mid-range and economy segment with low to medium requirements for positioning accuracy, the CP and CPS planetary gearboxes do not fail to impress. The key benefits offered by the gearboxes are high flexibility combined with maximum efficiency.

PRODUCT HIGHLIGHTS

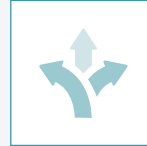

High flexibility

Different output variants offer design freedom tailored to individual requirements. The flexibility on the input side also enables the realization of different motor mounting versions.



Maximum economy

The gearboxes of the alpha Basic Line are extremely economical to purchase and highly efficient in operation.



Fast sizing

Efficient online sizing within seconds in the SIZING ASSISTANT on the basis of the application data or the motor.

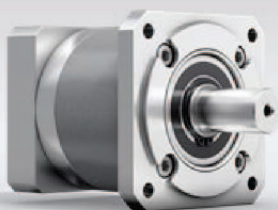

CPS – planetary gearbox with replaceable B5 output flange



CPS – planetary gearbox with long centering

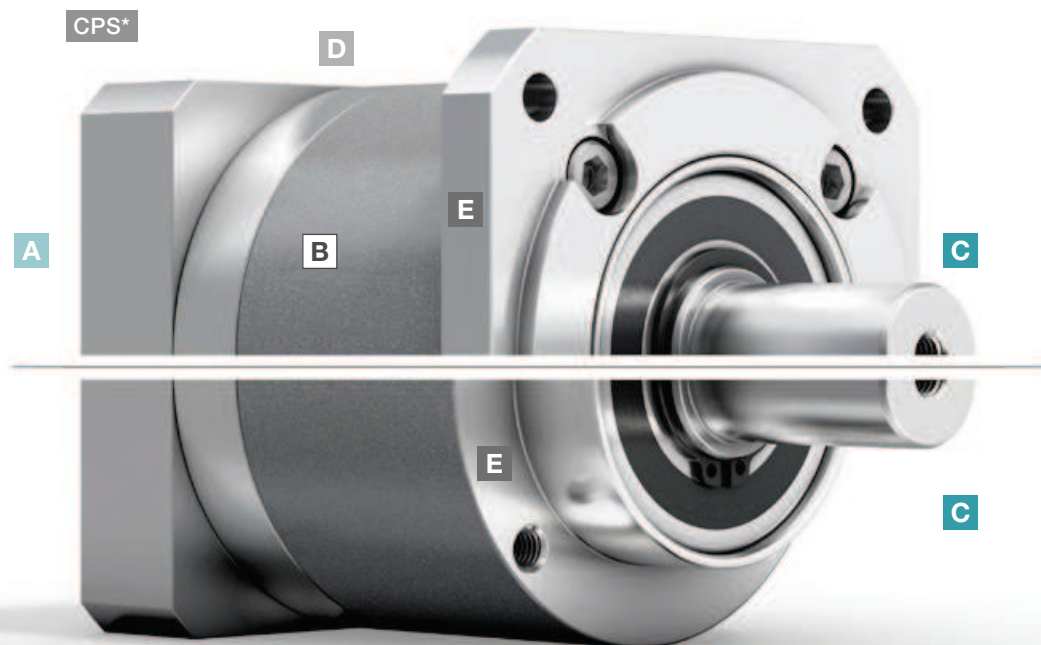

CPS

* CPS with replaceable B5 output flange

- A Flexible motor connection**
- Mounting of all common servo motors by means of a flexible and screw-fastened adapter plate
 - Large number of motor shaft diameters connectable

- B High ratio variation**
- Large number of ratios ($i=3$ to $i=100$)
 - Available in the common binary ratios

- C Various output shapes**
- With smooth shaft as well as shaft with key

- D Variety of sizes**
- CP available in five different sizes (005 – 045)
 - CPS available in three different sizes (015 – 035)

- E Variable application connection**
- Reduced installation space and maximum compactness thanks to a long centering
 - Flange attachment for B5 mounting

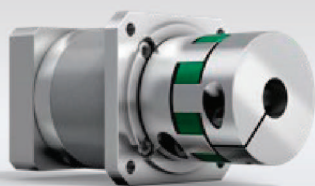

CPS – planetary gearbox with elastomer coupling



SIZING ASSISTANT
YOUR GEARBOX WITHIN SECONDS

Efficient gearbox sizing within seconds – online without login
www.sizing-assistant.com

CP 005 MF 1-stage

			1-stage					
Ratio	i		4	5	7	8	10	
Max. torque ^{a) b) e)}	T_{2a}	Nm	17	21	21	20	20	
		in.lb	150	186	186	177	177	
Max. acceleration torque ^{e)} (max. 1000 cycles per hour)	T_{2B}	Nm	11	14	14	13	13	
		in.lb	97	124	124	115	115	
Emergency stop torque ^{a) b) e)} (permitted 1000 times during the service life of the gearbox)	T_{2Not}	Nm	26	26	26	26	26	
		in.lb	230	230	230	230	230	
Permitted average input speed ^{d)} (at T_{2a} and 20 °C ambient temperature)	n_{1N}	rpm	3800	3800	4300	4300	4300	
Max. input speed	n_{1Max}	rpm	9000	9000	9000	9000	9000	
Mean no load running torque ^{b)} (at $n_1=3000$ rpm and 20 °C gearbox temperature)	T_{012}	Nm	0.07	0.06	0.06	0.06	0.05	
		in.lb	0.62	0.53	0.53	0.53	0.44	
Max. backlash	j_t	arcmin	≤ 12					
Torsional rigidity ^{b)}	C_{21}	Nm/arcmin	0.58	0.58	0.58	0.52	0.52	
		in.lb/arcmin	5.1	5.1	5.1	4.6	4.6	
Max. axial force ^{c)}	F_{2AMax}	N	240					
		lb _f	54					
Max. lateral force ^{c) 1)}	F_{2QMMax}	N	170					
		lb _f	38					
Max. tilting moment	M_{2KMMax}	Nm	4					
		in.lb	35					
Efficiency at full load	η	%	97					
Service life	L_n	h	> 20000					
Weight (incl. standard adapter plate)	m	kg	0.5					
		lb _m	1.1					
Operating noise (at reference ratio and reference speed – ratio-specific values available in cymex®)	L_{PA}	dB(A)	≤ 59					
Max. permitted housing temperature		°C	+90					
		°F	+194					
Ambient temperature		°C	-15 to +40					
		°F	+5 to +104					
Lubrication			Lubricated for life					
Direction of rotation			In- and output same direction					
Protection class			IP 64					
Elastomer coupling (recommended product type – validate sizing with cymex®)			ELC-0005BA010.000-X					
Bore diameter of coupling on the application side		mm	X = 004.000 - 012.700					
Mass moment of inertia (relates to the drive) Clamping hub diameter [mm]	B 11	J_1	kgcm ²	0.04	0.04	0.04	0.03	0.03
			10 ⁻³ in.lb.s ²	0.04	0.04	0.04	0.03	0.03

Please use our sizing software cymex® for a detailed sizing – www.wittenstein-cymex.com

^{a)} Valid for torque transmission only

^{b)} Valid for standard clamping hub diameter

^{c)} Refers to center of the output shaft or flange

^{d)} Please reduce input speed at higher ambient temperatures

^{e)} Valid for: Smooth shaft

¹⁾ At increased lateral forces – see glossary

Motor shaft diameter [mm]

1-stage

up to 11⁴⁾ (B)⁵⁾
clamping hub diameter

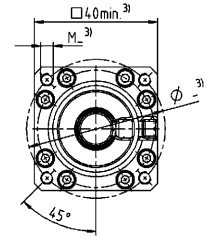
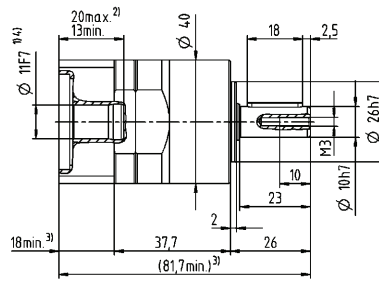
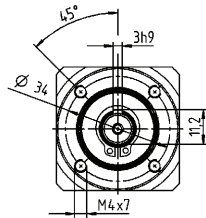

Other output variants

Smooth shaft

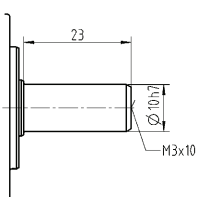

Non-tolerated dimensions are nominal dimensions

¹⁾ Check motor shaft fit

²⁾ Min. / Max. permissible motor shaft length

Longer motor shafts are possible, please contact alpha

³⁾ The dimensions depend on the motor

⁴⁾ Smaller motor shaft diameter is compensated by a bushing with a minimum thickness of 1 mm

⁵⁾ Standard clamping hub diameter

CP 005 MF 2-stage

			2-stage											
Ratio	i		16	20	25	28	32	35	40	50	64	70	100	
Max. torque ^{a) b) e)}	T_{2a}	Nm	17	17	21	17	17	21	17	21	20	21	20	
		in.lb	150	150	186	150	150	186	150	186	177	186	177	
Max. acceleration torque ^{a)} (max. 1000 cycles per hour)	T_{2B}	Nm	11	11	14	11	11	14	11	14	13	14	13	
		in.lb	97	97	124	97	97	124	97	124	115	124	115	
Emergency stop torque ^{a) b) e)} (permitted 1000 times during the service life of the gearbox)	T_{2Not}	Nm	26	26	26	26	26	26	26	26	26	26	26	
		in.lb	230	230	230	230	230	230	230	230	230	230	230	
Permitted average input speed ^{d)} (at T_{2a} and 20 °C ambient temperature)	n_{1N}	rpm	3800	3800	3800	3800	4300	4300	4300	4300	4300	4300	4300	
Max. input speed	n_{1Max}	rpm	9000	9000	9000	9000	9000	9000	9000	9000	9000	9000	9000	
Mean no load running torque ^{b)} (at $n_1=3000$ rpm and 20 °C gearbox temperature)	T_{012}	Nm	0.09	0.08	0.08	0.08	0.07	0.07	0.07	0.07	0.06	0.06	0.06	
		in.lb	0.8	0.71	0.71	0.71	0.62	0.62	0.62	0.62	0.53	0.53	0.53	
Max. backlash	j_t	arcmin	≤ 18											
Torsional rigidity ^{b)}	C_{121}	Nm/arcmin	0.58	0.58	0.58	0.58	0.58	0.58	0.58	0.58	0.52	0.58	0.52	
		in.lb/arcmin	5.1	5.1	5.1	5.1	5.1	5.1	5.1	5.1	4.6	5.1	4.6	
Max. axial force ^{c)}	F_{2AMax}	N	240											
		lb _f	54											
Max. lateral force ^{c) 1)}	F_{2QMMax}	N	170											
		lb _f	38											
Max. tilting moment	M_{2KMMax}	Nm	4											
		in.lb	35											
Efficiency at full load	η	%	95											
Service life	L_n	h	> 20000											
Weight (incl. standard adapter plate)	m	kg	0.7											
		lb _m	1.5											
Operating noise (at reference ratio and reference speed – ratio-specific values available in cymex®)	L_{PA}	dB(A)	≤ 59											
Max. permitted housing temperature		°C	+90											
		°F	+194											
Ambient temperature		°C	-15 to +40											
		°F	+5 to +104											
Lubrication			Lubricated for life											
Direction of rotation			In- and output same direction											
Protection class			IP 64											
Elastomer coupling (recommended product type – validate sizing with cymex®) Bore diameter of coupling on the application side			ELC-0005BA010.000-X											
		mm	X = 004.000 - 012.700											
Mass moment of inertia (relates to the drive) Clamping hub diameter [mm]	B	11	J_t	kgcm ²	0.04	0.04	0.04	0.04	0.04	0.04	0.04	0.03	0.03	0.03
				10 ⁻³ in.lb.s ²	0.04	0.04	0.04	0.04	0.04	0.04	0.04	0.03	0.03	0.03

Please use our sizing software cymex® for a detailed sizing – www.wittenstein-cymex.com

^{a)} Valid for torque transmission only

^{b)} Valid for standard clamping hub diameter

^{c)} Refers to center of the output shaft or flange

^{d)} Please reduce input speed at higher ambient temperatures

^{e)} Valid for: Smooth shaft

¹⁾ At increased lateral forces – see glossary

Motor shaft diameter [mm]

2-stage

up to 11⁴⁾ (B)⁵⁾
clamping hub diameter

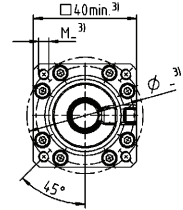
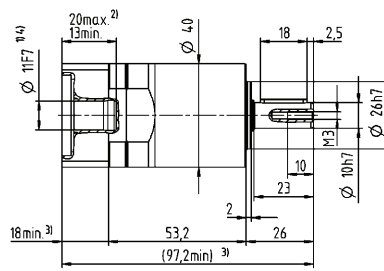
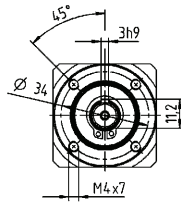

Other output variants

Smooth shaft

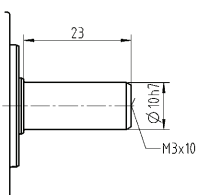

Non-tolerated dimensions are nominal dimensions

¹⁾ Check motor shaft fit

²⁾ Min. / Max. permissible motor shaft length

Longer motor shafts are possible, please contact alpha

³⁾ The dimensions depend on the motor

⁴⁾ Smaller motor shaft diameter is compensated by a bushing with a minimum thickness of 1 mm

⁵⁾ Standard clamping hub diameter

CP 015 MF 1-stage

			1-stage							
Ratio	i		3	4	5	7	8	10		
Max. torque ^{a) b) e)}	T_{2a}	Nm	48	56	58	58	56	56		
		in.lb	425	496	513	513	496	496		
Max. acceleration torque ^{a)} (max. 1000 cycles per hour)	T_{2B}	Nm	30	35	40	40	35	35		
		in.lb	266	310	354	354	310	310		
Emergency stop torque ^{a) b) e)} (permitted 1000 times during the service life of the gearbox)	T_{2Not}	Nm	75	75	75	75	75	75		
		in.lb	664	664	664	664	664	664		
Permitted average input speed ^{d)} (at T_{2a} and 20 °C ambient temperature)	n_{1N}	rpm	3300	3300	3300	4000	4000	4000		
Max. input speed	n_{1Max}	rpm	7000	7000	7000	7000	7000	7000		
Mean no load running torque ^{b)} (at $n_1=3000$ rpm and 20 °C gearbox temperature)	T_{012}	Nm	0.25	0.2	0.17	0.15	0.14	0.13		
		in.lb	2.2	1.8	1.5	1.3	1.2	1.2		
Max. backlash	j_t	arcmin	≤ 12							
Torsional rigidity ^{b)}	C_{t21}	Nm/arcmin	2.1	2.1	2.1	2.1	1.9	1.9		
		in.lb/arcmin	19	19	19	19	17	17		
Max. axial force ^{c)}	F_{2AMax}	N	750							
		lb _f	169							
Max. lateral force ^{c) 1)}	F_{2QMax}	N	500							
		lb _f	113							
Max. tilting moment	M_{2KMMax}	Nm	17							
		in.lb	150							
Efficiency at full load	η	%	97							
Service life	L_n	h	> 20000							
Weight (incl. standard adapter plate)	m	kg	1.4							
		lb _m	3.1							
Operating noise (at reference ratio and reference speed – ratio-specific values available in cymex®)	L_{PA}	dB(A)	≤ 60							
Max. permitted housing temperature		°C	+90							
		°F	+194							
Ambient temperature		°C	-15 to +40							
		°F	+5 to +104							
Lubrication			Lubricated for life							
Direction of rotation			In- and output same direction							
Protection class			IP 64							
Elastomer coupling (recommended product type – validate sizing with cymex®)			ELC-0020BA014.000-X							
Bore diameter of coupling on the application side		mm	X = 008.000 - 025.000							
Mass moment of inertia (relates to the drive) Clamping hub diameter [mm]	C	14	J_t	kgcm ²	0.23	0.2	0.18	0.15	0.15	0.15
				10 ⁻³ in.lb.s ²	0.2	0.18	0.16	0.13	0.13	0.13
	E	19	J_t	kgcm ²	0.43	0.4	0.39	0.38	0.38	0.37
				10 ⁻³ in.lb.s ²	0.38	0.35	0.35	0.34	0.34	0.33

Please use our sizing software cymex® for a detailed sizing – www.wittenstein-cymex.com

^{a)} Valid for torque transmission only

^{b)} Valid for standard clamping hub diameter

^{c)} Refers to center of the output shaft or flange

^{d)} Please reduce input speed at higher ambient temperatures

^{e)} Valid for: Smooth shaft

¹⁾ At increased lateral forces – see glossary

1-stage

up to 14⁴⁾ (C)⁵⁾
clamping hub
diameter

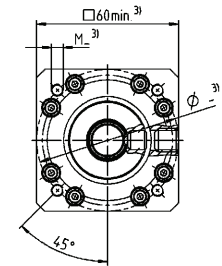
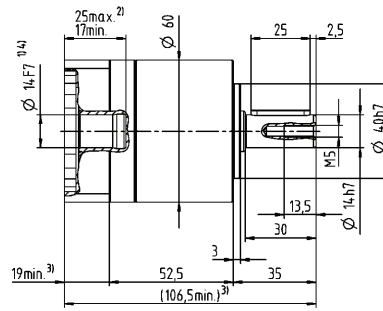
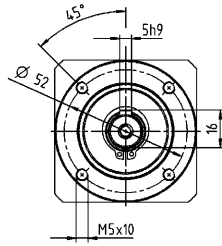

Motor shaft diameter [mm]

up to 19⁴⁾ (E)
clamping hub
diameter

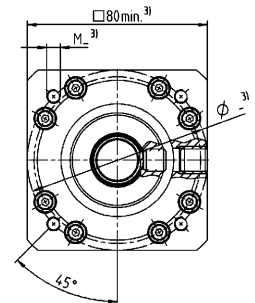
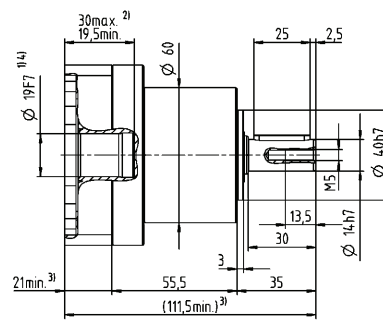
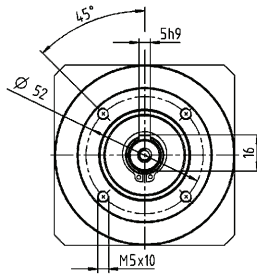

Other output variants

Smooth shaft

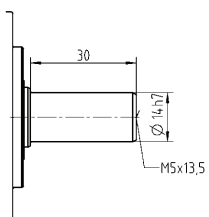

Non-tolerated dimensions are nominal dimensions

¹⁾ Check motor shaft fit

²⁾ Min. / Max. permissible motor shaft length

Longer motor shafts are possible, please contact alpha

³⁾ The dimensions depend on the motor

⁴⁾ Smaller motor shaft diameter is compensated

by a bushing with a minimum thickness of 1 mm

⁵⁾ Standard clamping hub diameter

CP 015 MF 2-stage

			2-stage															
Ratio	i		9	12	15	16	20	25	28	30	32	35	40	50	64	70	100	
Max. torque ^{a) b) e)}	T_{2a}	Nm	48	48	48	56	56	58	56	48	56	58	56	58	56	58	56	
		in.lb	425	425	425	496	496	513	496	425	496	513	496	513	496	513	496	
Max. acceleration torque ^{a)} (max. 1000 cycles per hour)	T_{2B}	Nm	30	30	30	35	35	40	35	30	35	40	35	40	35	40	35	
		in.lb	266	266	266	310	310	354	310	266	310	354	310	354	310	354	310	
Emergency stop torque ^{a) b) e)} (permitted 1000 times during the service life of the gearbox)	T_{2Not}	Nm	75	75	75	75	75	75	75	75	75	75	75	75	75	75	75	
		in.lb	664	664	664	664	664	664	664	664	664	664	664	664	664	664	664	
Permitted average input speed ^{d)} (at T_{2a} and 20 °C ambient temperature)	n_{1N}	rpm	3300	3300	3300	3300	3300	3300	3300	3300	3300	3300	3300	3300	4000	4000	4000	
Max. input speed	n_{1Max}	rpm	7000	7000	7000	7000	7000	7000	7000	7000	7000	7000	7000	7000	7000	7000	7000	
Mean no load running torque ^{b)} (at $n_1=3000$ rpm and 20 °C gearbox temperature)	T_{012}	Nm	0.33	0.28	0.26	0.25	0.22	0.21	0.2	0.21	0.19	0.18	0.17	0.16	0.16	0.15	0.14	
		in.lb	2.9	2.5	2.3	2.2	1.9	1.9	1.8	1.9	1.7	1.6	1.5	1.4	1.4	1.3	1.2	
Max. backlash	j_t	arcmin	≤ 15															
Torsional rigidity ^{b)}	C_{121}	Nm/arcmin	2.1	2.1	2.1	2.1	2.1	2.1	2.1	2.1	2.1	2.1	2.1	2.1	1.9	2.1	1.9	
		in.lb/arcmin	19	19	19	19	19	19	19	19	19	19	19	19	17	19	17	
Max. axial force ^{c)}	F_{2AMax}	N	750															
		lb _f	169															
Max. lateral force ^{c) 1)}	F_{2QMax}	N	500															
		lb _f	113															
Max. tilting moment	M_{2KMax}	Nm	17															
		in.lb	150															
Efficiency at full load	η	%	95															
Service life	L_n	h	> 20000															
Weight (incl. standard adapter plate)	m	kg	1.8															
		lb _m	4.0															
Operating noise (at reference ratio and reference speed – ratio-specific values available in cymex®)	L_{PA}	dB(A)	≤ 60															
Max. permitted housing temperature		°C	+90															
		°F	+194															
Ambient temperature		°C	-15 to +40															
		°F	+5 to +104															
Lubrication			Lubricated for life															
Direction of rotation			In- and output same direction															
Protection class			IP 64															
Elastomer coupling (recommended product type – validate sizing with cymex®)			ELC-0020BA014.000-X															
Bore diameter of coupling on the application side		mm	X = 008.000 - 025.000															
Mass moment of inertia (relates to the drive) Clamping hub diameter [mm]	C	14	J_t	kgcm ²	0.22	0.22	0.21	0.2	0.19	0.18	0.17	0.19	0.16	0.16	0.17	0.16	0.15	0.15
				10 ⁻³ in.lb.s ²	0.19	0.19	0.19	0.18	0.17	0.16	0.15	0.17	0.14	0.14	0.15	0.14	0.13	0.13
	E	19	J_t	kgcm ²	0.43	0.42	0.42	0.4	0.4	0.39	0.39	0.41	0.39	0.39	0.39	0.38	0.37	0.38
				10 ⁻³ in.lb.s ²	0.38	0.37	0.37	0.35	0.35	0.35	0.36	0.35	0.35	0.35	0.34	0.33	0.34	

Please use our sizing software cymex® for a detailed sizing – www.wittenstein-cymex.com

^{a)} Valid for torque transmission only

^{b)} Valid for standard clamping hub diameter

^{c)} Refers to center of the output shaft or flange

^{d)} Please reduce input speed at higher ambient temperatures

^{e)} Valid for: Smooth shaft

¹⁾ At increased lateral forces – see glossary

2-stage

up to 14⁴⁾ (C)⁵⁾
clamping hub
diameter

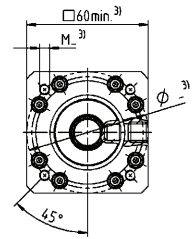
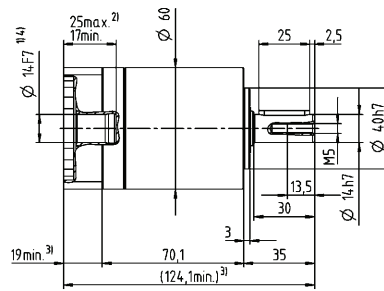
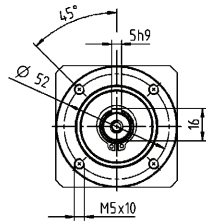

Motor shaft diameter [mm]

up to 19⁴⁾ (E)
clamping hub
diameter

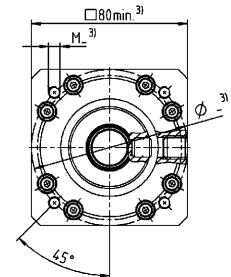
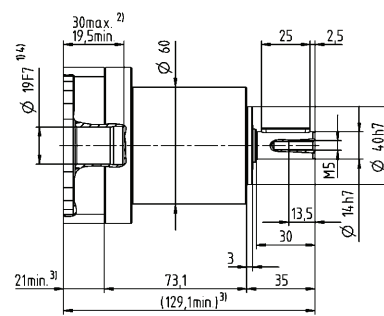
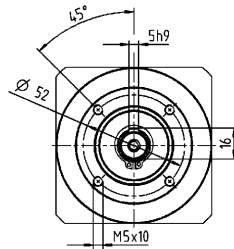

Other output variants

Smooth shaft

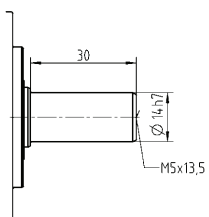

Non-tolerated dimensions are nominal dimensions

¹⁾ Check motor shaft fit

²⁾ Min. / Max. permissible motor shaft length

Longer motor shafts are possible, please contact alpha

³⁾ The dimensions depend on the motor

⁴⁾ Smaller motor shaft diameter is compensated by a bushing with a minimum thickness of 1 mm

⁵⁾ Standard clamping hub diameter

CP 025 MF 1-stage

			1-stage							
Ratio	i		3	4	5	7	8	10		
Max. torque ^{a) b) e)}	T_{2a}	Nm	112	150	150	150	144	144		
		in.lb	991	1328	1328	1328	1275	1275		
Max. acceleration torque ^{a)} (max. 1000 cycles per hour)	T_{2B}	Nm	70	95	100	100	90	90		
		in.lb	620	841	885	885	797	797		
Emergency stop torque ^{a) b) e)} (permitted 1000 times during the service life of the gearbox)	T_{2Not}	Nm	114	152	187	187	187	187		
		in.lb	1009	1345	1655	1655	1655	1655		
Permitted average input speed ^{d)} (at T_{2a} and 20 °C ambient temperature)	n_{1N}	rpm	3100	3100	3100	3600	3600	3600		
Max. input speed	n_{1Max}	rpm	7000	7000	7000	7000	7000	7000		
Mean no load running torque ^{b)} (at $n_1=3000$ rpm and 20 °C gearbox temperature)	T_{012}	Nm	0.38	0.3	0.26	0.23	0.21	0.19		
		in.lb	3.4	2.7	2.3	2	1.9	1.7		
Max. backlash	j_t	arcmin	≤ 12							
Torsional rigidity ^{b)}	C_{t21}	Nm/arcmin	6.1	6.1	6.1	6.1	5.5	5.5		
		in.lb/arcmin	54	54	54	54	49	49		
Max. axial force ^{c)}	F_{2AMax}	N	1600							
		lb _f	360							
Max. lateral force ^{c)}	F_{2QMMax}	N	1200							
		lb _f	270							
Max. tilting moment	M_{2KMMax}	Nm	54							
		in.lb	478							
Efficiency at full load	η	%	97							
Service life	L_n	h	> 20000							
Weight (incl. standard adapter plate)	m	kg	2.9							
		lb _m	6.4							
Operating noise (at reference ratio and reference speed – ratio-specific values available in cymex®)	L_{PA}	dB(A)	≤ 62							
Max. permitted housing temperature		°C	+90							
		°F	+194							
Ambient temperature		°C	-15 to +40							
		°F	+5 to +104							
Lubrication			Lubricated for life							
Direction of rotation			In- and output same direction							
Protection class			IP 64							
Elastomer coupling (recommended product type – validate sizing with cymex®)			ELC-0060BA020.000-X							
Bore diameter of coupling on the application side		mm	X = 012.000 - 032.000							
Mass moment of inertia (relates to the drive) Clamping hub diameter [mm]	E	19	J_1	kgcm ²	0.66	0.53	0.48	0.43	0.41	0.4
				10 ⁻³ in.lb.s ²	0.58	0.47	0.42	0.38	0.36	0.35
	G	24	J_1	kgcm ²	1.5	1.4	1.3	1.3	1.3	1.3
				10 ⁻³ in.lb.s ²	1.3	1.2	1.2	1.2	1.2	1.2

Please use our sizing software cymex® for a detailed sizing – www.wittenstein-cymex.com

^{a)} Valid for torque transmission only

^{b)} Valid for standard clamping hub diameter

^{c)} Refers to center of the output shaft or flange

^{d)} Please reduce input speed at higher ambient temperatures

^{e)} Valid for: Smooth shaft

1-stage

up to 19⁴⁾ (E)⁵⁾
clamping hub
diameter

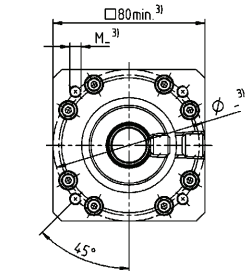
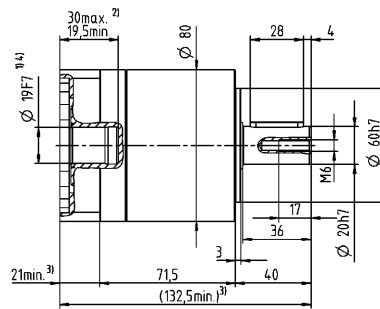
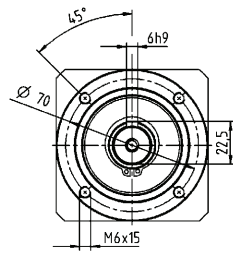

up to 24⁴⁾ (G)
clamping hub
diameter

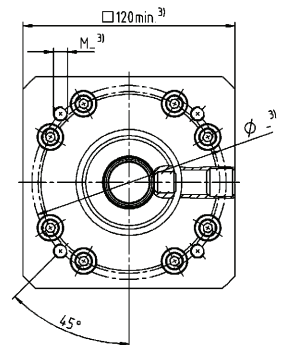
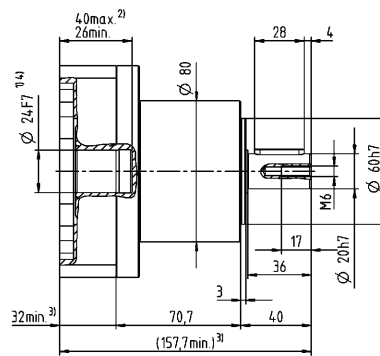
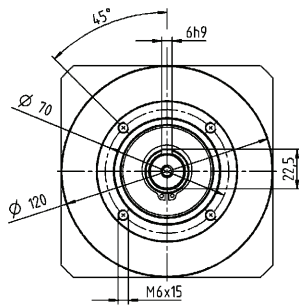

Motor shaft diameter [mm]

Planetary Gearboxes
Basic Line

Other output variants

Smooth shaft

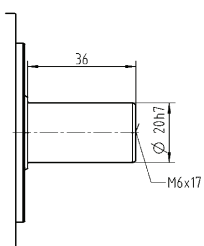

Non-tolerated dimensions are nominal dimensions

¹⁾ Check motor shaft fit

²⁾ Min. / Max. permissible motor shaft length

Longer motor shafts are possible, please contact alpha

³⁾ The dimensions depend on the motor

⁴⁾ Smaller motor shaft diameter is compensated by a bushing with a minimum thickness of 1 mm

⁵⁾ Standard clamping hub diameter

CP 025 MF 2-stage

			2-stage																
Ratio	i		9	12	15	16	20	25	28	30	32	35	40	50	64	70	100		
Max. torque ^{a) b) e)}	T_{2a}	Nm	112	112	112	150	150	150	150	112	150	150	150	150	144	150	144		
		in.lb	991	991	991	1328	1328	1328	1328	991	1328	1328	1328	1328	1275	1328	1275		
Max. acceleration torque ^{a)} (max. 1000 cycles per hour)	T_{2B}	Nm	70	70	70	95	95	95	95	70	95	100	95	100	90	100	90		
		in.lb	620	620	620	841	841	841	841	620	841	885	841	885	797	885	797		
Emergency stop torque ^{a) b) e)} (permitted 1000 times during the service life of the gearbox)	T_{2Not}	Nm	187	187	187	187	187	187	187	187	187	187	187	187	187	187	187		
		in.lb	1655	1655	1655	1655	1655	1655	1655	1655	1655	1655	1655	1655	1655	1655	1655		
Permitted average input speed ^{d)} (at T_{2a} and 20 °C ambient temperature)	n_{1N}	rpm	3100	3100	3100	3100	3100	3100	3100	3100	3100	3100	3100	3100	3600	3600	3600		
Max. input speed	n_{1Max}	rpm	7000	7000	7000	7000	7000	7000	7000	7000	7000	7000	7000	7000	7000	7000	7000		
Mean no load running torque ^{b)} (at $n_1=3000$ rpm and 20 °C gearbox temperature)	T_{012}	Nm	0.5	0.43	0.39	0.38	0.34	0.32	0.3	0.31	0.28	0.28	0.26	0.24	0.23	0.22	0.21		
		in.lb	4.4	3.8	3.5	3.4	3	2.8	2.7	2.7	2.5	2.5	2.3	2.1	2	1.9	1.9		
Max. backlash	j_t	arcmin	≤ 15																
Torsional rigidity ^{b)}	C_{121}	Nm/arcmin	6.1	6.1	6.1	6.1	6.1	6.1	6.1	6.1	6.1	6.1	6.1	6.1	5.5	6.1	5.5		
		in.lb/arcmin	54	54	54	54	54	54	54	54	54	54	54	54	49	54	49		
Max. axial force ^{c)}	F_{2AMax}	N	1600																
		lb _f	360																
Max. lateral force ^{c)}	F_{2QMMax}	N	1200																
		lb _f	270																
Max. tilting moment	M_{2KMMax}	Nm	54																
		in.lb	478																
Efficiency at full load	η	%	95																
Service life	L_n	h	> 20000																
Weight (incl. standard adapter plate)	m	kg	3.7																
		lb _m	8.2																
Operating noise (at reference ratio and reference speed – ratio-specific values available in cymex®)	L_{PA}	dB(A)	≤ 62																
Max. permitted housing temperature		°C	+90																
		°F	+194																
Ambient temperature		°C	-15 to +40																
		°F	+5 to +104																
Lubrication			Lubricated for life																
Direction of rotation			In- and output same direction																
Protection class			IP 64																
Elastomer coupling (recommended product type – validate sizing with cymex®)			ELC-0060BA020.000-X																
Bore diameter of coupling on the application side		mm	X = 012.000 - 032.000																
Mass moment of inertia (relates to the drive) Clamping hub diameter [mm]	E	19	J_t	kgcm ²	0.66	1.4	1.6	0.98	1.1	0.82	1.2	2.1	1.4	0.88	1.4	1	0.58	0.71	0.54
				10 ⁻³ in.lb.s ²	0.58	1.2	1.4	0.87	0.97	0.73	1.1	1.9	1.2	0.78	1.2	0.89	0.51	0.63	0.48
	G	24	J_t	kgcm ²	1.5	2.3	2.4	1.8	1.9	1.7	2	3	2.2	1.7	2.2	1.9	1.4	1.6	1.4
				10 ⁻³ in.lb.s ²	1.3	2	2.1	1.6	1.7	1.5	1.8	2.7	1.9	1.5	1.9	1.7	1.2	1.4	1.2

Please use our sizing software cymex® for a detailed sizing – www.wittenstein-cymex.com

^{a)} Valid for torque transmission only

^{b)} Valid for standard clamping hub diameter

^{c)} Refers to center of the output shaft or flange

^{d)} Please reduce input speed at higher ambient temperatures

^{e)} Valid for: Smooth shaft

2-stage

up to 19⁴⁾ (E)⁵⁾
clamping hub
diameter

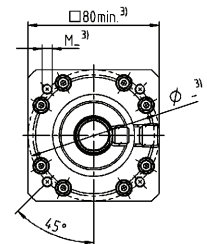
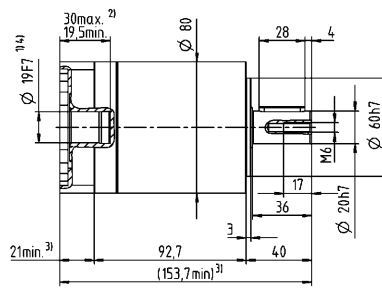
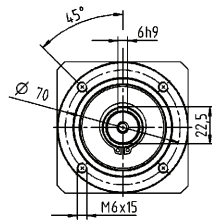

Motor shaft diameter [mm]

up to 24⁴⁾ (G)
clamping hub
diameter

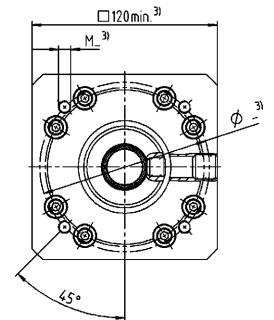
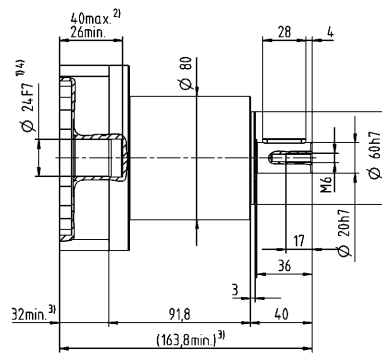
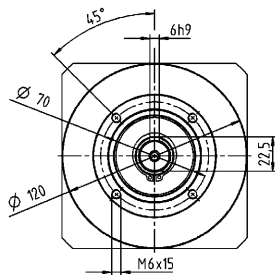

Other output variants

Smooth shaft

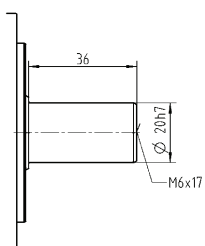

Non-tolerated dimensions are nominal dimensions

¹⁾ Check motor shaft fit

²⁾ Min. / Max. permissible motor shaft length

Longer motor shafts are possible, please contact alpha

³⁾ The dimensions depend on the motor

⁴⁾ Smaller motor shaft diameter is compensated by a bushing with a minimum thickness of 1 mm

⁵⁾ Standard clamping hub diameter

CP 035 MF 1-stage

			1-stage							
Ratio	i		3	4	5	7	8	10		
Max. torque ^{a) b) e)}	T_{2a}	Nm	272	272	272	272	272	272		
		in.lb	2407	2407	2407	2407	2407	2407		
Max. acceleration torque ^{a)} (max. 1000 cycles per hour)	T_{2B}	Nm	175	255	250	250	220	220		
		in.lb	1549	2257	2213	2213	1947	1947		
Emergency stop torque ^{a) b) e)} (permitted 1000 times during the service life of the gearbox)	T_{2Not}	Nm	460	480	480	480	470	480		
		in.lb	4071	4248	4248	4248	4160	4248		
Permitted average input speed ^{d)} (at T_{2a} and 20 °C ambient temperature)	n_{1N}	rpm	2300	2300	2300	2800	2800	2800		
Max. input speed	n_{1Max}	rpm	5500	5500	5500	5500	5500	5500		
Mean no load running torque ^{b)} (at $n_1=3000$ rpm and 20 °C gearbox temperature)	T_{012}	Nm	0.95	0.76	0.66	0.57	0.52	0.48		
		in.lb	8.4	6.7	5.8	5	4.6	4.2		
Max. backlash	j_t	arcmin	≤ 12							
Torsional rigidity ^{b)}	C_{t21}	Nm/arcmin	16	16	16	16	14	14		
		in.lb/arcmin	142	142	142	142	124	124		
Max. axial force ^{c)}	F_{2AMax}	N	2500							
		lb _f	563							
Max. lateral force ^{c)}	F_{2QMax}	N	1750							
		lb _f	394							
Max. tilting moment	M_{2KMMax}	Nm	98							
		in.lb	867							
Efficiency at full load	η	%	97							
Service life	L_n	h	> 20000							
Weight (incl. standard adapter plate)	m	kg	7.5							
		lb _m	17							
Operating noise (at reference ratio and reference speed – ratio-specific values available in cymex®)	L_{PA}	dB(A)	≤ 66							
Max. permitted housing temperature		°C	+90							
		°F	+194							
Ambient temperature		°C	-15 to +40							
		°F	+5 to +104							
Lubrication			Lubricated for life							
Direction of rotation			In- and output same direction							
Protection class			IP 64							
Elastomer coupling (recommended product type – validate sizing with cymex®)			ELC-0150BA025.000-X							
Bore diameter of coupling on the application side		mm	X = 019.000 - 036.000							
Mass moment of inertia (relates to the drive) Clamping hub diameter [mm]	G	24	J_t	kgcm ²	2.6	1.9	1.7	1.5	1.4	1.4
				10 ⁻³ in.lb.s ²	2.3	1.7	1.5	1.3	1.2	1.2
	K	38	J_t	kgcm ²	7.8	7.1	6.9	6.7	6.6	6.5
				10 ⁻³ in.lb.s ²	6.9	6.3	6.1	5.9	5.8	5.8

Please use our sizing software cymex® for a detailed sizing – www.wittenstein-cymex.com

^{a)} Valid for torque transmission only

^{b)} Valid for standard clamping hub diameter

^{c)} Refers to center of the output shaft or flange

^{d)} Please reduce input speed at higher ambient temperatures

^{e)} Valid for: Smooth shaft

1-stage

up to 24⁴⁾ (G)⁵⁾
clamping hub
diameter

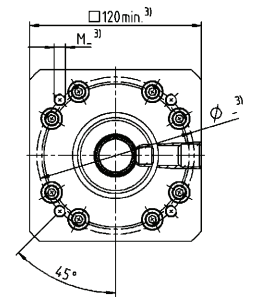
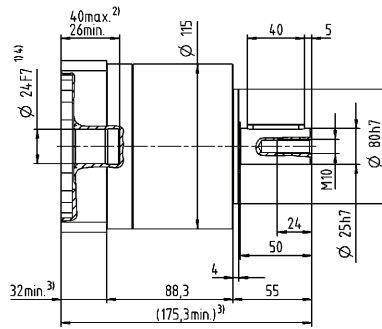
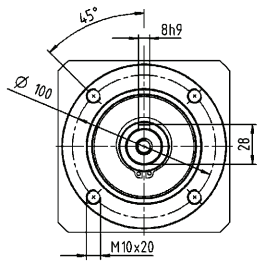

Motor shaft diameter [mm]

up to 38⁴⁾ (K)
clamping hub
diameter

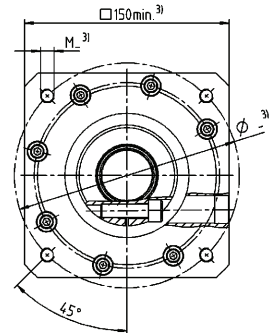
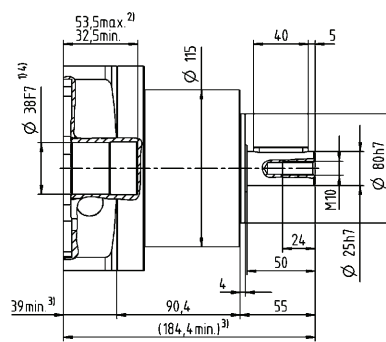
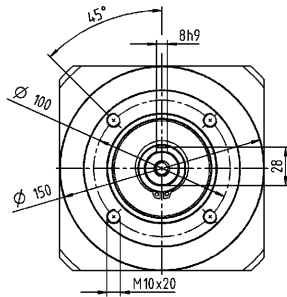

Planetary Gearboxes
Basic Line

Other output variants

Smooth shaft

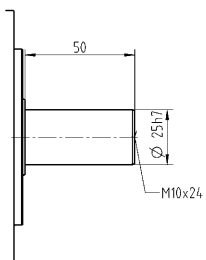

Non-tolerated dimensions are nominal dimensions

¹⁾ Check motor shaft fit

²⁾ Min. / Max. permissible motor shaft length

Longer motor shafts are possible, please contact alpha

³⁾ The dimensions depend on the motor

⁴⁾ Smaller motor shaft diameter is compensated by a bushing with a minimum thickness of 1 mm

⁵⁾ Standard clamping hub diameter

CP 035 MF 2-stage

			2-stage																
Ratio	i		9	12	15	16	20	25	28	30	32	35	40	50	64	70	100		
Max. torque ^{a) b) e)}	T_{2a}	Nm	272	272	272	272	272	272	272	272	272	272	272	272	272	272	272		
		in.lb	2407	2407	2407	2407	2407	2407	2407	2407	2407	2407	2407	2407	2407	2407	2407	2407	
Max. acceleration torque ^{a)} (max. 1000 cycles per hour)	T_{2B}	Nm	175	175	175	255	255	250	255	175	255	250	255	250	220	250	220		
		in.lb	1549	1549	1549	2257	2257	2213	2257	1549	2257	2213	2257	2213	1947	2213	1947		
Emergency stop torque ^{a) b) e)} (permitted 1000 times during the service life of the gearbox)	T_{2Not}	Nm	480	480	480	480	480	480	480	315	480	480	480	480	470	480	480		
		in.lb	4248	4248	4248	4248	4248	4248	4248	2788	4248	4248	4248	4248	4160	4248	4248		
Permitted average input speed ^{d)} (at T_{2a} and 20 °C ambient temperature)	n_{1N}	rpm	2300	2300	2300	2300	2300	2300	2300	2300	2300	2300	2300	2300	2800	2800	2800		
Max. input speed	n_{1Max}	rpm	5500	5500	5500	5500	5500	5500	5500	5500	5500	5500	5500	5500	5500	5500	5500		
Mean no load running torque ^{b)} (at $n_1=3000$ rpm and 20 °C gearbox temperature)	T_{012}	Nm	1.3	1.1	0.98	0.95	0.85	0.8	0.76	0.79	0.71	0.7	0.66	0.61	0.59	0.56	0.52		
		in.lb	12	9.7	8.7	8.4	7.5	7.1	6.7	7	6.3	6.2	5.8	5.4	5.2	5	4.6		
Max. backlash	j_t	arcmin	≤ 15																
Torsional rigidity ^{b)}	C_{121}	Nm/arcmin	16	16	16	16	16	16	16	16	16	16	16	16	14	16	14		
		in.lb/arcmin	142	142	142	142	142	142	142	142	142	142	142	142	124	142	124		
Max. axial force ^{c)}	F_{2AMax}	N	2500																
		lb _f	563																
Max. lateral force ^{c)}	F_{2QMax}	N	1750																
		lb _f	394																
Max. tilting moment	M_{2KMMax}	Nm	98																
		in.lb	867																
Efficiency at full load	η	%	95																
Service life	L_n	h	> 20000																
Weight (incl. standard adapter plate)	m	kg	9.6																
		lb _m	21																
Operating noise (at reference ratio and reference speed – ratio-specific values available in cymex®)	L_{PA}	dB(A)	≤ 66																
Max. permitted housing temperature		°C	+90																
		°F	+194																
Ambient temperature		°C	-15 to +40																
		°F	+5 to +104																
Lubrication			Lubricated for life																
Direction of rotation			In- and output same direction																
Protection class			IP 64																
Elastomer coupling (recommended product type – validate sizing with cymex®)			ELC-0150BA025.000-X																
Bore diameter of coupling on the application side		mm	X = 019.000 - 036.000																
Mass moment of inertia (relates to the drive) Clamping hub diameter [mm]	G	24	J_1	kgcm ²	2.7	2.5	2.5	2.3	2.3	2.1	2.4	3.1	2.4	2.2	2.6	2.2	1.8	1.9	1.7
				10 ⁻³ in.lb.s ²	2.4	2.2	2.2	2	2	1.9	2.1	2.7	2.1	1.9	2.3	1.9	1.6	1.7	1.5
	K	38	J_1	kgcm ²	7.9	7.7	7.8	7.5	7.5	7.3	7.5	8.3	7.6	7.4	7.8	7.4	7	7.1	6.9
				10 ⁻³ in.lb.s ²	7	6.8	6.9	6.6	6.6	6.5	6.6	7.3	6.7	6.5	6.9	6.5	6.2	6.3	6.1

Please use our sizing software cymex® for a detailed sizing – www.wittenstein-cymex.com

^{a)} Valid for torque transmission only

^{b)} Valid for standard clamping hub diameter

^{c)} Refers to center of the output shaft or flange

^{d)} Please reduce input speed at higher ambient temperatures

^{e)} Valid for: Smooth shaft

2-stage

up to 24⁴⁾ (G)⁵⁾
clamping hub
diameter

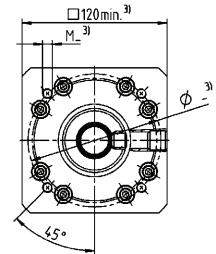
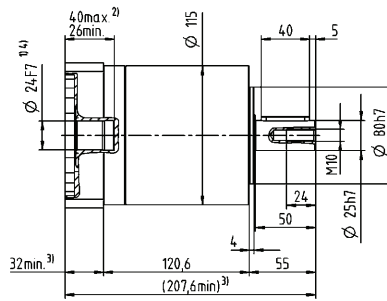
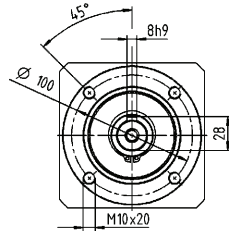

Motor shaft diameter [mm]

up to 38⁴⁾ (K)
clamping hub
diameter

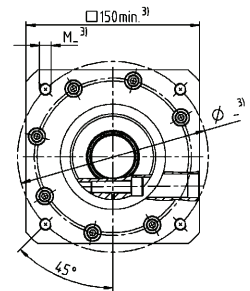
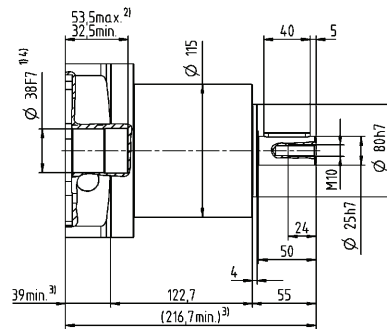
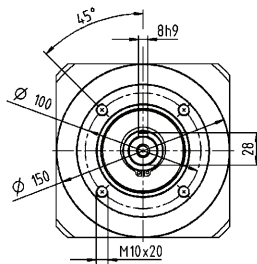

Other output variants

Smooth shaft

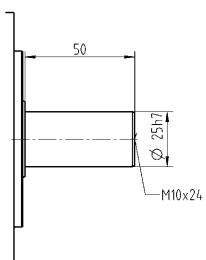

Non-tolerated dimensions are nominal dimensions

¹⁾ Check motor shaft fit

²⁾ Min. / Max. permissible motor shaft length

Longer motor shafts are possible, please contact alpha

³⁾ The dimensions depend on the motor

⁴⁾ Smaller motor shaft diameter is compensated by a bushing with a minimum thickness of 1 mm

⁵⁾ Standard clamping hub diameter

CP 045 MF 1-/2-stage

			1-stage			2-stage						
Ratio	i		5	8	10	25	32	50	64	100		
Max. torque ^{a) b) e)}	T_{2a}	Nm	800	640	640	700	640	700	640	640		
		in.lb	7081	5665	5665	6196	5665	6196	5665	5665		
Max. acceleration torque ^{e)} (max. 1000 cycles per hour)	T_{2B}	Nm	500	400	400	500	400	500	400	400		
		in.lb	4425	3540	3540	4425	3540	4425	3540	3540		
Emergency stop torque ^{a) b) e)} (permitted 1000 times during the service life of the gearbox)	T_{2Not}	Nm	1000	1000	1000	1000	1000	1000	1000	1000		
		in.lb	8851	8851	8851	8851	8851	8851	8851	8851		
Permitted average input speed ^{d)} (at T_{2N} and 20 °C ambient temperature)	n_{1N}	rpm	2000	2200	2300	2600	2500	3000	2900	3000		
Max. input speed	n_{1Max}	rpm	4000	4000	4000	6000	6000	6000	6000	6000		
Mean no load running torque ^{b)} (at $n_1=3000$ rpm and 20 °C gearbox temperature)	T_{012}	Nm	2.4	2	1.9	0.8	0.68	0.6	0.6	0.55		
		in.lb	21	18	17	7.1	6	5.3	5.3	4.9		
Max. backlash	j_i	arcmin	≤ 12			≤ 15						
Torsional rigidity ^{b)}	C_{t21}	Nm/arcmin	55	44	44	55	55	55	44	44		
		in.lb/arcmin	487	389	389	487	487	487	389	389		
Max. axial force ^{c)}	F_{2AMax}	N	6000			6000						
		lb _f	6000			6000						
Max. lateral force ^{c)}	F_{2OMax}	N	8000			8000						
		lb _f	8000			8000						
Max. tilting moment	M_{2KMMax}	Nm	704			704						
		in.lb	6231			6231						
Efficiency at full load	η	%	97			95						
Service life	L_n	h	> 20000			> 20000						
Weight (incl. standard adapter plate)	m	kg	20			21						
		lb _m	44			46						
Operating noise (at reference ratio and reference speed – ratio-specific values available in cymex®)	L_{PA}	dB(A)	≤ 68			≤ 65						
Max. permitted housing temperature		°C	+90			+90						
		°F	+194			+194						
Ambient temperature		°C	-15 to +40			-15 to +40						
		°F	+5 to +104			+5 to +104						
Lubrication			Lubricated for life									
Direction of rotation			In- and output same direction									
Protection class			IP 64									
Elastomer coupling (recommended product type – validate sizing with cymex®)			ELC-0300BA040.000-X									
Bore diameter of coupling on the application side		mm	X = 020.000 - 045.000									
Mass moment of inertia (relates to the drive) Clamping hub diameter [mm]	E	19	J_i	kgcm ²	–	–	–	1.2	1.1	1.1	0.88	0.82
				10 ⁻³ in.lb.s ²	–	–	–	1,1	0,97	0,97	0,78	0,73
	G	24	J_i	kgcm ²	–	–	–	2	1,9	1,8	1,7	1,6
				10 ⁻³ in.lb.s ²	–	–	–	1,8	1,7	1,6	1,5	1,4
	H	28	J_i	kgcm ²	–	–	–	1,7	1,6	1,5	1,4	1,3
				10 ⁻³ in.lb.s ²	–	–	–	1,5	1,4	1,3	1,2	1,2
	I	32	J_i	kgcm ²	–	–	–	5,8	5,7	5,6	5,4	5,4
				10 ⁻³ in.lb.s ²	–	–	–	5,1	5	5	4,8	4,8
	K	38	J_i	kgcm ²	8.8	7.4	7.2	7	6,9	6,8	6,6	6,5
				10 ⁻³ in.lb.s ²	7.8	6.5	6.4	6,2	6,1	6	5,8	5,8

Please use our sizing software cymex® for a detailed sizing – www.wittenstein-cymex.com

^{a)} Valid for torque transmission only

^{b)} Valid for standard clamping hub diameter

^{c)} Refers to center of the output shaft or flange

^{d)} Please reduce input speed at higher ambient temperatures

^{e)} Valid for: Smooth shaft

1-stage

up to 38⁴⁾ (K)⁵⁾
clamping hub
diameter

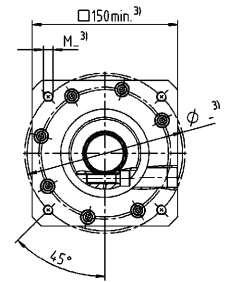
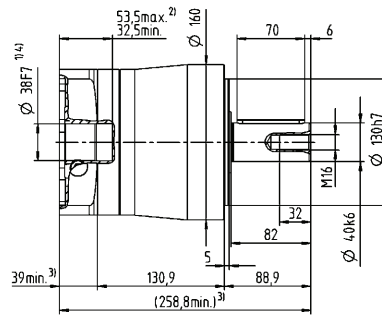
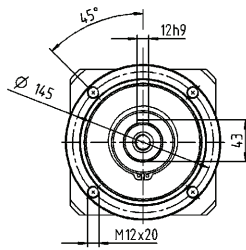

2-stage

up to 19/24/28⁴⁾
(E/G⁵⁾/H)
clamping hub
diameter

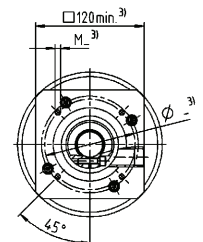
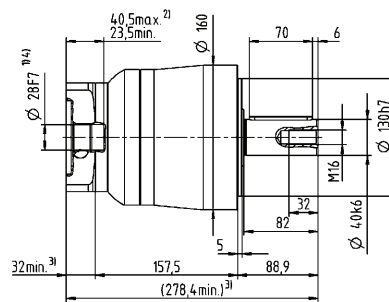
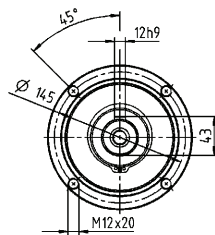

up to 32/38⁴⁾
(I/K)
clamping hub
diameter

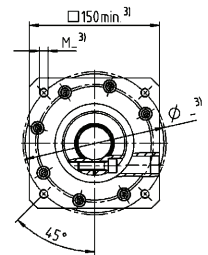
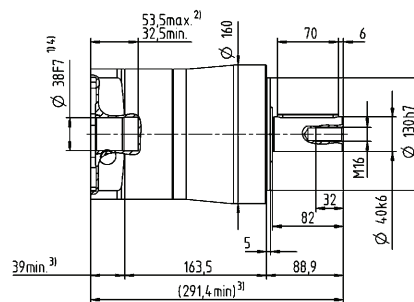
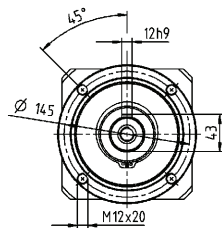

Motor shaft diameter [mm]

Other output variants

Smooth shaft

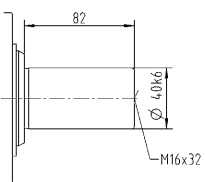

Non-tolerated dimensions are nominal dimensions

¹⁾ Check motor shaft fit

²⁾ Min. / Max. permissible motor shaft length

Longer motor shafts are possible, please contact alpha

³⁾ The dimensions depend on the motor

⁴⁾ Smaller motor shaft diameter is compensated

by a bushing with a minimum thickness of 1 mm

⁵⁾ Standard clamping hub diameter

CPS 015 MF 1-stage

			1-stage							
Ratio	i		3	4	5	7	8	10		
Max. torque ^{a) b) e)}	T_{2a}	Nm	48	56	58	58	56	56		
		in.lb	425	496	513	513	496	496		
Max. acceleration torque ^{a)} (max. 1000 cycles per hour)	T_{2B}	Nm	30	35	40	40	35	35		
		in.lb	266	310	354	354	310	310		
Emergency stop torque ^{a) b) e)} (permitted 1000 times during the service life of the gearbox)	T_{2Not}	Nm	75	75	75	75	75	75		
		in.lb	664	664	664	664	664	664		
Permitted average input speed ^{d)} (at T_{2a} and 20 °C ambient temperature)	n_{1N}	rpm	3300	3300	3300	4000	4000	4000		
Max. input speed	n_{1Max}	rpm	7000	7000	7000	7000	7000	7000		
Mean no load running torque ^{b)} (at $n_1=3000$ rpm and 20 °C gearbox temperature)	T_{012}	Nm	0.25	0.2	0.17	0.15	0.14	0.13		
		in.lb	2.2	1.8	1.5	1.3	1.2	1.2		
Max. backlash	j_t	arcmin	≤ 12							
Torsional rigidity ^{b)}	C_{t21}	Nm/arcmin	2.1	2.1	2.1	2.1	1.9	1.9		
		in.lb/arcmin	19	19	19	19	17	17		
Max. axial force ^{c)}	F_{2AMax}	N	750							
		lb _f	169							
Max. lateral force ^{c)}	F_{2QMax}	N	500							
		lb _f	113							
Max. tilting moment	M_{2KMMax}	Nm	17							
		in.lb	150							
Efficiency at full load	η	%	97							
Service life	L_n	h	> 20000							
Weight (incl. standard adapter plate)	m	kg	1.4							
		lb _m	3.1							
Operating noise (at reference ratio and reference speed – ratio-specific values available in cymex®)	L_{PA}	dB(A)	≤ 60							
Max. permitted housing temperature		°C	+90							
		°F	+194							
Ambient temperature		°C	-15 to +40							
		°F	+5 to +104							
Lubrication			Lubricated for life							
Direction of rotation			In- and output same direction							
Protection class			IP 64							
Elastomer coupling (recommended product type – validate sizing with cymex®)			ELC-0020BA014.000-X							
Bore diameter of coupling on the application side		mm	X = 008.000 - 025.000							
Mass moment of inertia (relates to the drive) Clamping hub diameter [mm]	C	14	J_t	kgcm ²	0.23	0.2	0.18	0.15	0.15	0.15
				10 ⁻³ in.lb.s ²	0.2	0.18	0.16	0.13	0.13	0.13
	E	19	J_t	kgcm ²	0.43	0.4	0.39	0.38	0.38	0.37
				10 ⁻³ in.lb.s ²	0.38	0.35	0.35	0.34	0.34	0.33

Please use our sizing software cymex® for a detailed sizing – www.wittenstein-cymex.com

^{a)} Valid for torque transmission only

^{b)} Valid for standard clamping hub diameter

^{c)} Refers to center of the output shaft or flange

^{d)} Please reduce input speed at higher ambient temperatures

^{e)} Valid for: Smooth shaft

1-stage

up to 14⁴⁾ (C)⁵⁾
clamping hub
diameter

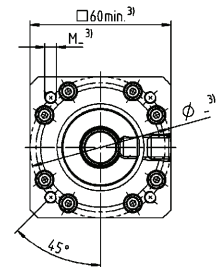
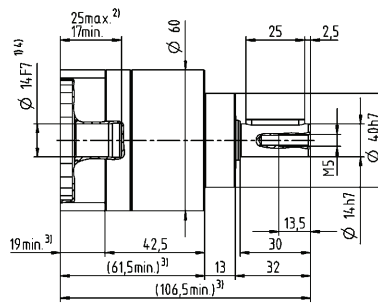
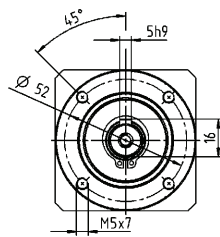

Motor shaft diameter [mm]

up to 19⁴⁾ (E)
clamping hub
diameter

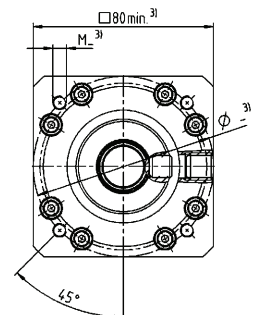
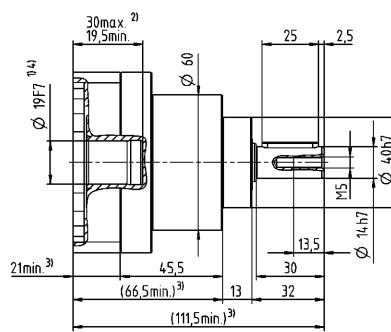
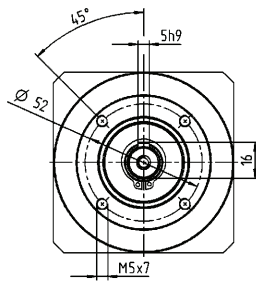

Other output variants

Smooth shaft

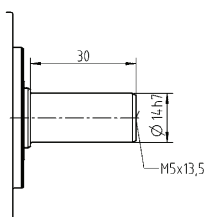

Replaceable B5 output flange

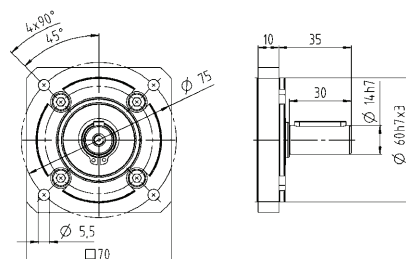

Non-tolerated dimensions are nominal dimensions

¹⁾ Check motor shaft fit

²⁾ Min. / Max. permissible motor shaft length

Longer motor shafts are possible, please contact alpha

³⁾ The dimensions depend on the motor

⁴⁾ Smaller motor shaft diameter is compensated

by a bushing with a minimum thickness of 1 mm

⁵⁾ Standard clamping hub diameter

CPS 015 MF 2-stage

			2-stage															
Ratio	i		9	12	15	16	20	25	28	30	32	35	40	50	64	70	100	
Max. torque ^{a) b) e)}	T_{2a}	Nm	48	48	48	56	56	58	56	48	56	58	56	58	56	58	56	
		in.lb	425	425	425	496	496	513	496	425	496	513	496	513	496	513	496	
Max. acceleration torque ^{a)} (max. 1000 cycles per hour)	T_{2B}	Nm	30	30	30	35	35	40	35	30	35	40	35	40	35	40	35	
		in.lb	266	266	266	310	310	354	310	266	310	354	310	354	310	354	310	
Emergency stop torque ^{a) b) e)} (permitted 1000 times during the service life of the gearbox)	T_{2Not}	Nm	75	75	75	75	75	75	75	75	75	75	75	75	75	75	75	
		in.lb	664	664	664	664	664	664	664	664	664	664	664	664	664	664	664	
Permitted average input speed ^{d)} (at T_{2a} and 20 °C ambient temperature)	n_{1N}	rpm	3300	3300	3300	3300	3300	3300	3300	3300	3300	3300	3300	3300	4000	4000	4000	
Max. input speed	n_{1Max}	rpm	7000	7000	7000	7000	7000	7000	7000	7000	7000	7000	7000	7000	7000	7000	7000	
Mean no load running torque ^{b)} (at $n_1=3000$ rpm and 20 °C gearbox temperature)	T_{012}	Nm	0.33	0.28	0.26	0.25	0.22	0.21	0.2	0.21	0.19	0.18	0.17	0.16	0.16	0.15	0.14	
		in.lb	2.9	2.5	2.3	2.2	1.9	1.9	1.8	1.9	1.7	1.6	1.5	1.4	1.4	1.3	1.2	
Max. backlash	j_t	arcmin	≤ 15															
Torsional rigidity ^{b)}	C_{121}	Nm/arcmin	2.1	2.1	2.1	2.1	2.1	2.1	2.1	2.1	2.1	2.1	2.1	2.1	1.9	2.1	1.9	
		in.lb/arcmin	19	19	19	19	19	19	19	19	19	19	19	19	17	19	17	
Max. axial force ^{c)}	F_{2AMax}	N	750															
		lb _f	169															
Max. lateral force ^{c)}	F_{2QMMax}	N	500															
		lb _f	113															
Max. tilting moment	M_{2KMMax}	Nm	17															
		in.lb	150															
Efficiency at full load	η	%	95															
Service life	L_n	h	> 20000															
Weight (incl. standard adapter plate)	m	kg	1.8															
		lb _m	4.0															
Operating noise (at reference ratio and reference speed – ratio-specific values available in cymex®)	L_{PA}	dB(A)	≤ 60															
Max. permitted housing temperature		°C	+90															
		°F	+194															
Ambient temperature		°C	-15 to +40															
		°F	+5 to +104															
Lubrication			Lubricated for life															
Direction of rotation			In- and output same direction															
Protection class			IP 64															
Elastomer coupling (recommended product type – validate sizing with cymex®)			ELC-0020BA014.000-X															
Bore diameter of coupling on the application side		mm	X = 008.000 - 025.000															
Mass moment of inertia (relates to the drive) Clamping hub diameter [mm]	C	14	J_t	kgcm ²	0.22	0.22	0.21	0.2	0.19	0.18	0.17	0.19	0.16	0.16	0.17	0.16	0.15	0.15
				10 ⁻³ in.lb.s ²	0.19	0.19	0.19	0.18	0.17	0.16	0.15	0.17	0.14	0.14	0.15	0.14	0.13	0.13
	E	19	J_t	kgcm ²	0.43	0.42	0.42	0.4	0.4	0.39	0.39	0.41	0.39	0.39	0.39	0.38	0.37	0.38
				10 ⁻³ in.lb.s ²	0.38	0.37	0.37	0.35	0.35	0.35	0.36	0.35	0.35	0.35	0.34	0.33	0.34	

Please use our sizing software cymex® for a detailed sizing – www.wittenstein-cymex.com

^{a)} Valid for torque transmission only

^{b)} Valid for standard clamping hub diameter

^{c)} Refers to center of the output shaft or flange

^{d)} Please reduce input speed at higher ambient temperatures

^{e)} Valid for: Smooth shaft

2-stage

Motor shaft diameter [mm]

up to 14⁴⁾ (C)⁵⁾
clamping hub
diameter

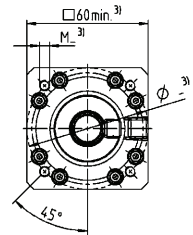
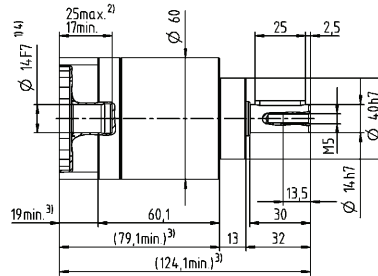
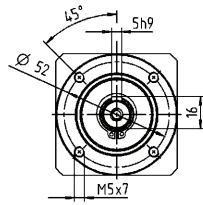

up to 19⁴⁾ (E)
clamping hub
diameter

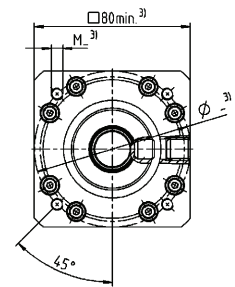
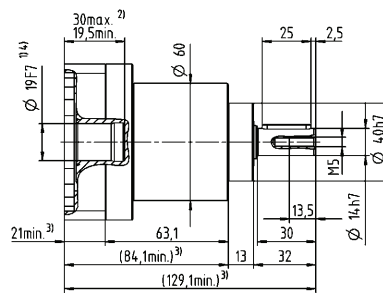
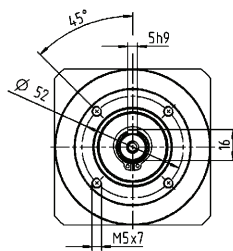

Other output variants

Smooth shaft

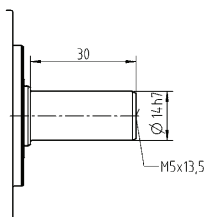

Replaceable B5 output flange

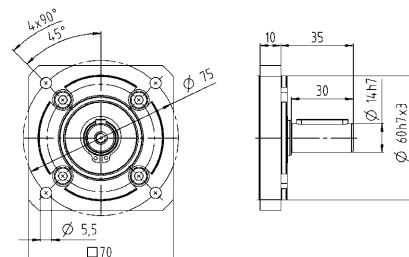

Non-tolerated dimensions are nominal dimensions

¹⁾ Check motor shaft fit

²⁾ Min. / Max. permissible motor shaft length

Longer motor shafts are possible, please contact alpha

³⁾ The dimensions depend on the motor

⁴⁾ Smaller motor shaft diameter is compensated by a bushing with a minimum thickness of 1 mm

⁵⁾ Standard clamping hub diameter

CPS 025 MF 1-stage

			1-stage							
Ratio	i		3	4	5	7	8	10		
Max. torque ^{a) b) e)}	T_{2a}	Nm	112	150	150	150	144	144		
		in.lb	991	1328	1328	1328	1275	1275		
Max. acceleration torque ^{a)} (max. 1000 cycles per hour)	T_{2B}	Nm	70	95	100	100	90	90		
		in.lb	620	841	885	885	797	797		
Emergency stop torque ^{a) b) e)} (permitted 1000 times during the service life of the gearbox)	T_{2Not}	Nm	114	152	187	187	187	187		
		in.lb	1009	1345	1655	1655	1655	1655		
Permitted average input speed ^{d)} (at T_{2a} and 20 °C ambient temperature)	n_{1N}	rpm	3100	3100	3100	3600	3600	3600		
Max. input speed	n_{1Max}	rpm	7000	7000	7000	7000	7000	7000		
Mean no load running torque ^{b)} (at $n_1=3000$ rpm and 20 °C gearbox temperature)	T_{012}	Nm	0.38	0.3	0.26	0.23	0.21	0.19		
		in.lb	3.4	2.7	2.3	2	1.9	1.7		
Max. backlash	j_t	arcmin	≤ 12							
Torsional rigidity ^{b)}	C_{t21}	Nm/arcmin	6.1	6.1	6.1	6.1	5.5	5.5		
		in.lb/arcmin	54	54	54	54	49	49		
Max. axial force ^{c)}	F_{2AMax}	N	1600							
		lb _f	360							
Max. lateral force ^{c)}	F_{2QMMax}	N	1200							
		lb _f	270							
Max. tilting moment	M_{2KMMax}	Nm	54							
		in.lb	478							
Efficiency at full load	η	%	97							
Service life	L_n	h	> 20000							
Weight (incl. standard adapter plate)	m	kg	2.9							
		lb _m	6.4							
Operating noise (at reference ratio and reference speed – ratio-specific values available in cymex®)	L_{PA}	dB(A)	≤ 62							
Max. permitted housing temperature		°C	+90							
		°F	+194							
Ambient temperature		°C	-15 to +40							
		°F	+5 to +104							
Lubrication			Lubricated for life							
Direction of rotation			In- and output same direction							
Protection class			IP 64							
Elastomer coupling (recommended product type – validate sizing with cymex®)			ELC-0060BA020.000-X							
Bore diameter of coupling on the application side		mm	X = 012.000 - 032.000							
Mass moment of inertia (relates to the drive) Clamping hub diameter [mm]	E	19	J_1	kgcm ²	0.66	0.53	0.48	0.43	0.41	0.4
				10 ⁻³ in.lb.s ²	0.58	0.47	0.42	0.38	0.36	0.35
	G	24	J_1	kgcm ²	1.5	1.4	1.3	1.3	1.3	1.3
				10 ⁻³ in.lb.s ²	1.3	1.2	1.2	1.2	1.2	1.2

Please use our sizing software cymex® for a detailed sizing – www.wittenstein-cymex.com

^{a)} Valid for torque transmission only

^{b)} Valid for standard clamping hub diameter

^{c)} Refers to center of the output shaft or flange

^{d)} Please reduce input speed at higher ambient temperatures

^{e)} Valid for: Smooth shaft

1-stage

up to 19⁴⁾ (E)⁵⁾
clamping hub
diameter

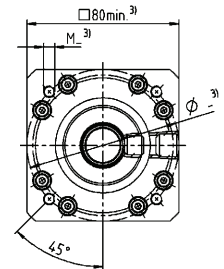
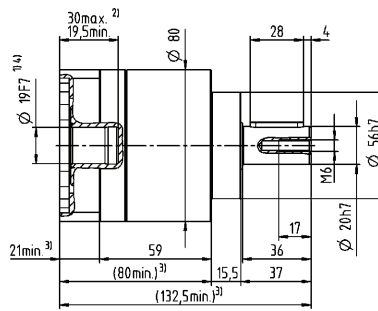
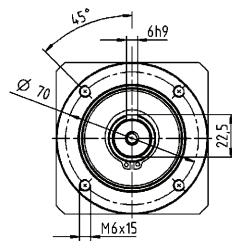

up to 24⁴⁾ (G)
clamping hub
diameter

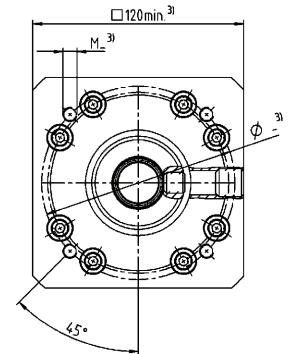
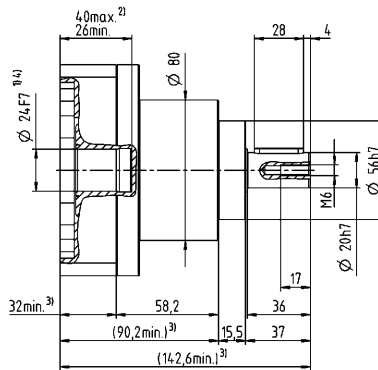
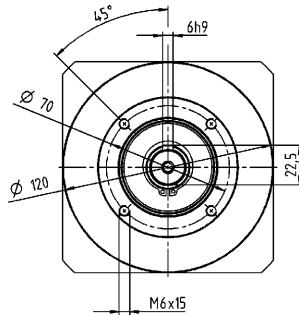

Motor shaft diameter [mm]

Planetary Gearboxes
Basic Line

Other output variants

Smooth shaft

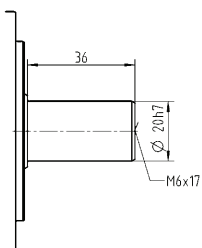

Replaceable B5 output flange

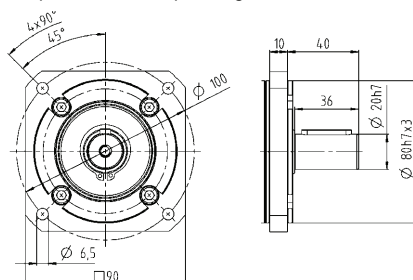

Non-tolerated dimensions are nominal dimensions

¹⁾ Check motor shaft fit

²⁾ Min. / Max. permissible motor shaft length

Longer motor shafts are possible, please contact alpha

³⁾ The dimensions depend on the motor

⁴⁾ Smaller motor shaft diameter is compensated

by a bushing with a minimum thickness of 1 mm

⁵⁾ Standard clamping hub diameter

CPS 025 MF 2-stage

			2-stage																
Ratio	i		9	12	15	16	20	25	28	30	32	35	40	50	64	70	100		
Max. torque ^{a) b) e)}	T_{2a}	Nm	112	112	112	150	150	150	150	112	150	150	150	150	144	150	144		
		in.lb	991	991	991	1328	1328	1328	1328	991	1328	1328	1328	1328	1275	1328	1275		
Max. acceleration torque ^{a)} (max. 1000 cycles per hour)	T_{2B}	Nm	70	70	70	95	95	95	95	70	95	100	95	100	90	100	90		
		in.lb	620	620	620	841	841	841	841	620	841	885	841	885	797	885	797		
Emergency stop torque ^{a) b) e)} (permitted 1000 times during the service life of the gearbox)	T_{2Not}	Nm	187	187	187	187	187	187	187	187	187	187	187	187	187	187	187		
		in.lb	1655	1655	1655	1655	1655	1655	1655	1655	1655	1655	1655	1655	1655	1655	1655		
Permitted average input speed ^{d)} (at T_{2a} and 20 °C ambient temperature)	n_{1N}	rpm	3100	3100	3100	3100	3100	3100	3100	3100	3100	3100	3100	3100	3600	3600	3600		
Max. input speed	n_{1Max}	rpm	7000	7000	7000	7000	7000	7000	7000	7000	7000	7000	7000	7000	7000	7000	7000		
Mean no load running torque ^{b)} (at $n_1=3000$ rpm and 20 °C gearbox temperature)	T_{012}	Nm	0.5	0.43	0.39	0.38	0.34	0.32	0.3	0.31	0.28	0.28	0.26	0.24	0.23	0.22	0.21		
		in.lb	4.4	3.8	3.5	3.4	3	2.8	2.7	2.7	2.5	2.5	2.3	2.1	2	1.9	1.9		
Max. backlash	j_t	arcmin	≤ 15																
Torsional rigidity ^{b)}	C_{121}	Nm/arcmin	6.1	6.1	6.1	6.1	6.1	6.1	6.1	6.1	6.1	6.1	6.1	6.1	5.5	6.1	5.5		
		in.lb/arcmin	54	54	54	54	54	54	54	54	54	54	54	54	49	54	49		
Max. axial force ^{c)}	F_{2AMax}	N	1600																
		lb _f	360																
Max. lateral force ^{c)}	F_{2QMMax}	N	1200																
		lb _f	270																
Max. tilting moment	M_{2KMMax}	Nm	54																
		in.lb	478																
Efficiency at full load	η	%	95																
Service life	L_n	h	> 20000																
Weight (incl. standard adapter plate)	m	kg	3.7																
		lb _m	8.2																
Operating noise (at reference ratio and reference speed – ratio-specific values available in cymex®)	L_{PA}	dB(A)	≤ 62																
Max. permitted housing temperature		°C	+90																
		°F	+194																
Ambient temperature		°C	-15 to +40																
		°F	+5 to +104																
Lubrication			Lubricated for life																
Direction of rotation			In- and output same direction																
Protection class			IP 64																
Elastomer coupling (recommended product type – validate sizing with cymex®)			ELC-0060BA020.000-X																
Bore diameter of coupling on the application side		mm	X = 012.000 - 032.000																
Mass moment of inertia (relates to the drive) Clamping hub diameter [mm]	E	19	J_t	kgcm ²	0.66	1.4	1.6	0.98	1.1	0.82	1.2	2.1	1.4	0.88	1.4	1	0.58	0.71	0.54
				10 ⁻³ in.lb.s ²	0.58	1.2	1.4	0.87	0.97	0.73	1.1	1.9	1.2	0.78	1.2	0.89	0.51	0.63	0.48
	G	24	J_t	kgcm ²	1.5	2.3	2.4	1.8	1.9	1.7	2	3	2.2	1.7	2.2	1.9	1.4	1.6	1.4
				10 ⁻³ in.lb.s ²	1.3	2	2.1	1.6	1.7	1.5	1.8	2.7	1.9	1.5	1.9	1.7	1.2	1.4	1.2

Please use our sizing software cymex® for a detailed sizing – www.wittenstein-cymex.com

^{a)} Valid for torque transmission only

^{b)} Valid for standard clamping hub diameter

^{c)} Refers to center of the output shaft or flange

^{d)} Please reduce input speed at higher ambient temperatures

^{e)} Valid for: Smooth shaft

2-stage

up to 19⁴⁾ (E)⁵⁾
clamping hub
diameter

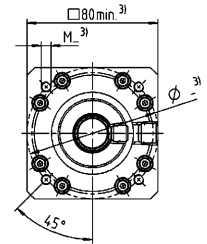
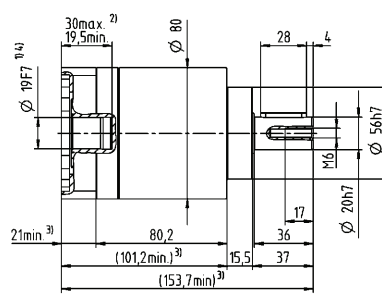
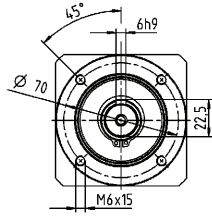

Motor shaft diameter [mm]

up to 24⁴⁾ (G)
clamping hub
diameter

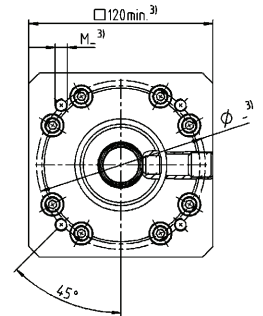
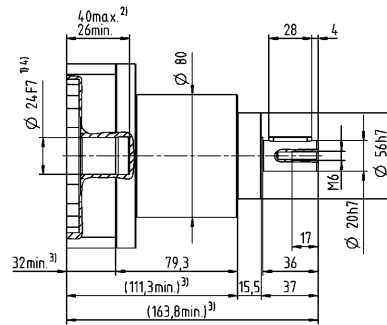
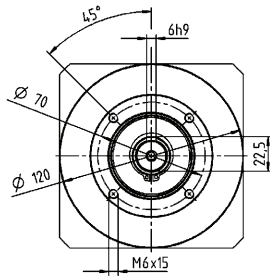

Other output variants

Smooth shaft

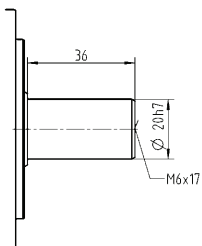

Replaceable B5 output flange

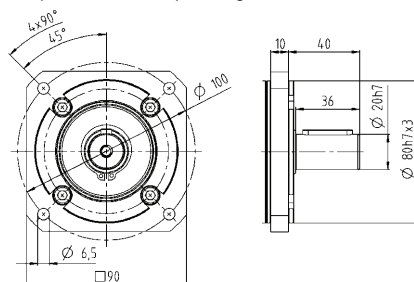

Non-tolerated dimensions are nominal dimensions

¹⁾ Check motor shaft fit

²⁾ Min. / Max. permissible motor shaft length

Longer motor shafts are possible, please contact alpha

³⁾ The dimensions depend on the motor

⁴⁾ Smaller motor shaft diameter is compensated by a bushing with a minimum thickness of 1 mm

⁵⁾ Standard clamping hub diameter

CPS 035 MF 1-stage

			1-stage							
Ratio	i		3	4	5	7	8	10		
Max. torque ^{a) b) e)}	T_{2a}	Nm	272	272	272	272	272	272		
		in.lb	2407	2407	2407	2407	2407	2407		
Max. acceleration torque ^{a)} (max. 1000 cycles per hour)	T_{2B}	Nm	175	255	250	250	220	220		
		in.lb	1549	2257	2213	2213	1947	1947		
Emergency stop torque ^{a) b) e)} (permitted 1000 times during the service life of the gearbox)	T_{2Not}	Nm	460	480	480	480	470	480		
		in.lb	4071	4248	4248	4248	4160	4248		
Permitted average input speed ^{d)} (at T_{2a} and 20 °C ambient temperature)	n_{1N}	rpm	2300	2300	2300	2800	2800	2800		
Max. input speed	n_{1Max}	rpm	5500	5500	5500	5500	5500	5500		
Mean no load running torque ^{b)} (at $n_1=3000$ rpm and 20 °C gearbox temperature)	T_{012}	Nm	0.95	0.76	0.66	0.57	0.52	0.48		
		in.lb	8.4	6.7	5.8	5	4.6	4.2		
Max. backlash	j_t	arcmin	≤ 12							
Torsional rigidity ^{b)}	C_{t21}	Nm/arcmin	16	16	16	16	14	14		
		in.lb/arcmin	142	142	142	142	124	124		
Max. axial force ^{c)}	F_{2AMax}	N	2500							
		lb _f	563							
Max. lateral force ^{c)}	F_{2QMMax}	N	1750							
		lb _f	394							
Max. tilting moment	M_{2KMMax}	Nm	98							
		in.lb	867							
Efficiency at full load	η	%	97							
Service life	L_n	h	> 20000							
Weight (incl. standard adapter plate)	m	kg	7.5							
		lb _m	17							
Operating noise (at reference ratio and reference speed – ratio-specific values available in cymex®)	L_{PA}	dB(A)	≤ 66							
Max. permitted housing temperature		°C	+90							
		°F	+194							
Ambient temperature		°C	-15 to +40							
		°F	+5 to +104							
Lubrication			Lubricated for life							
Direction of rotation			In- and output same direction							
Protection class			IP 64							
Elastomer coupling (recommended product type – validate sizing with cymex®)			ELC-0150BA025.000-X							
Bore diameter of coupling on the application side		mm	X = 019.000 - 036.000							
Mass moment of inertia (relates to the drive) Clamping hub diameter [mm]	G	24	J_t	kgcm ²	2.6	1.9	1.7	1.5	1.4	1.4
				10 ⁻³ in.lb.s ²	2.3	1.7	1.5	1.3	1.2	1.2
	K	38	J_t	kgcm ²	7.8	7.1	6.9	6.7	6.6	6.5
				10 ⁻³ in.lb.s ²	6.9	6.3	6.1	5.9	5.8	5.8

Please use our sizing software cymex® for a detailed sizing – www.wittenstein-cymex.com

^{a)} Valid for torque transmission only

^{b)} Valid for standard clamping hub diameter

^{c)} Refers to center of the output shaft or flange

^{d)} Please reduce input speed at higher ambient temperatures

^{e)} Valid for: Smooth shaft

1-stage

up to 24⁴⁾ (G)⁵⁾
clamping hub
diameter

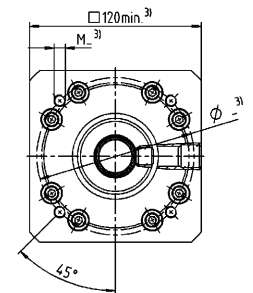
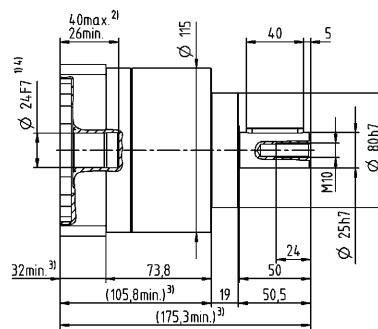
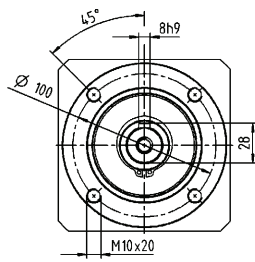

up to 38⁴⁾ (K)
clamping hub
diameter

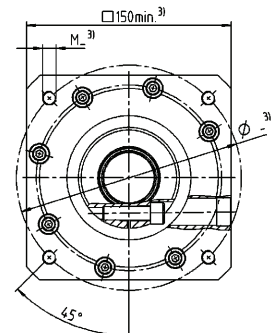
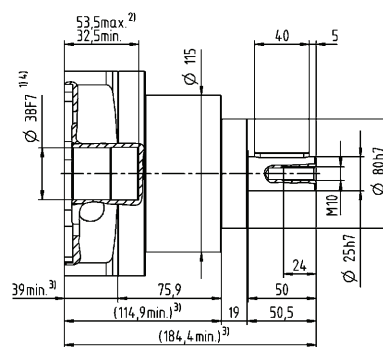
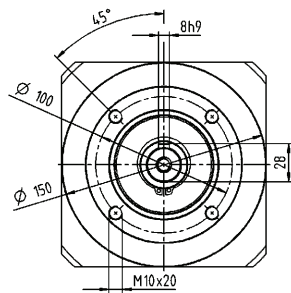

Motor shaft diameter [mm]

Other output variants

Smooth shaft

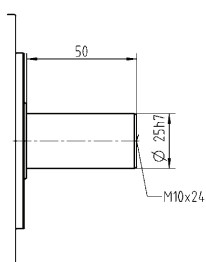

Replaceable B5 output flange

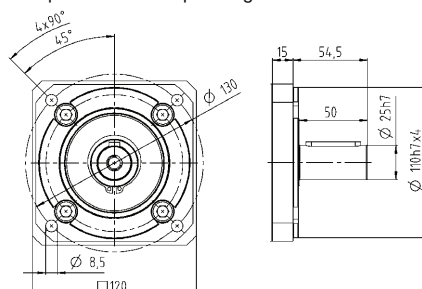

Non-tolerated dimensions are nominal dimensions

¹⁾ Check motor shaft fit

²⁾ Min. / Max. permissible motor shaft length

Longer motor shafts are possible, please contact alpha

³⁾ The dimensions depend on the motor

⁴⁾ Smaller motor shaft diameter is compensated by a bushing with a minimum thickness of 1 mm

⁵⁾ Standard clamping hub diameter

CPS 035 MF 2-stage

			2-stage																
Ratio	i		9	12	15	16	20	25	28	30	32	35	40	50	64	70	100		
Max. torque ^{a) b) e)}	T_{2a}	Nm	272	272	272	272	272	272	272	272	272	272	272	272	272	272	272		
		in.lb	2407	2407	2407	2407	2407	2407	2407	2407	2407	2407	2407	2407	2407	2407	2407	2407	
Max. acceleration torque ^{a)} (max. 1000 cycles per hour)	T_{2B}	Nm	175	175	175	255	255	250	255	175	255	250	255	250	220	250	220		
		in.lb	1549	1549	1549	2257	2257	2213	2257	1549	2257	2213	2257	2213	1947	2213	1947		
Emergency stop torque ^{a) b) e)} (permitted 1000 times during the service life of the gearbox)	T_{2Not}	Nm	480	480	480	480	480	480	480	315	480	480	480	480	470	480	480		
		in.lb	4248	4248	4248	4248	4248	4248	4248	2788	4248	4248	4248	4248	4160	4248	4248		
Permitted average input speed ^{d)} (at T_{2a} and 20 °C ambient temperature)	n_{1N}	rpm	2300	2300	2300	2300	2300	2300	2300	2300	2300	2300	2300	2300	2800	2800	2800		
Max. input speed	n_{1Max}	rpm	5500	5500	5500	5500	5500	5500	5500	5500	5500	5500	5500	5500	5500	5500	5500		
Mean no load running torque ^{b)} (at $n_1=3000$ rpm and 20 °C gearbox temperature)	T_{012}	Nm	1.3	1.1	0.98	0.95	0.85	0.8	0.76	0.79	0.71	0.7	0.66	0.61	0.59	0.56	0.52		
		in.lb	12	9.7	8.7	8.4	7.5	7.1	6.7	7	6.3	6.2	5.8	5.4	5.2	5	4.6		
Max. backlash	j_t	arcmin	≤ 15																
Torsional rigidity ^{b)}	C_{121}	Nm/arcmin	16	16	16	16	16	16	16	16	16	16	16	16	14	16	14		
		in.lb/arcmin	142	142	142	142	142	142	142	142	142	142	142	142	124	142	124		
Max. axial force ^{c)}	F_{2AMax}	N	2500																
		lb _f	563																
Max. lateral force ^{c)}	F_{2QMax}	N	1750																
		lb _f	394																
Max. tilting moment	M_{2KMMax}	Nm	98																
		in.lb	867																
Efficiency at full load	η	%	95																
Service life	L_n	h	> 20000																
Weight (incl. standard adapter plate)	m	kg	9.6																
		lb _m	21																
Operating noise (at reference ratio and reference speed – ratio-specific values available in cymex®)	L_{PA}	dB(A)	≤ 66																
Max. permitted housing temperature		°C	+90																
		°F	+194																
Ambient temperature		°C	-15 to +40																
		°F	+5 to +104																
Lubrication			Lubricated for life																
Direction of rotation			In- and output same direction																
Protection class			IP 64																
Elastomer coupling (recommended product type – validate sizing with cymex®)			ELC-0150BA025.000-X																
Bore diameter of coupling on the application side		mm	X = 019.000 - 036.000																
Mass moment of inertia (relates to the drive) Clamping hub diameter [mm]	G	24	J_t	kgcm ²	2.7	2.5	2.5	2.3	2.3	2.1	2.4	3.1	2.4	2.2	2.6	2.2	1.8	1.9	1.7
				10 ⁻³ in.lb.s ²	2.4	2.2	2.2	2	2	1.9	2.1	2.7	2.1	1.9	2.3	1.9	1.6	1.7	1.5
	K	38	J_t	kgcm ²	7.9	7.7	7.8	7.5	7.5	7.3	7.5	8.3	7.6	7.4	7.8	7.4	7	7.1	6.9
				10 ⁻³ in.lb.s ²	7	6.8	6.9	6.6	6.6	6.5	6.6	7.3	6.7	6.5	6.9	6.5	6.2	6.3	6.1

Please use our sizing software cymex® for a detailed sizing – www.wittenstein-cymex.com

^{a)} Valid for torque transmission only

^{b)} Valid for standard clamping hub diameter

^{c)} Refers to center of the output shaft or flange

^{d)} Please reduce input speed at higher ambient temperatures

^{e)} Valid for: Smooth shaft

2-stage

up to 24⁴⁾ (G)⁵⁾
clamping hub diameter

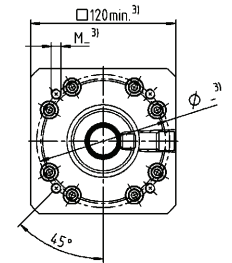
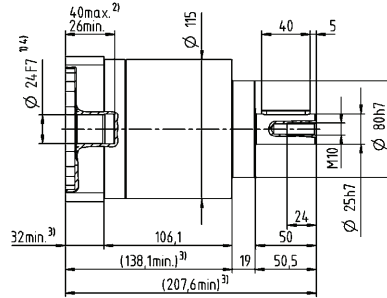
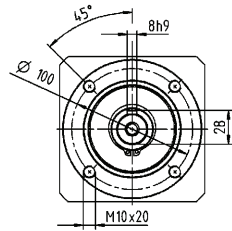

Motor shaft diameter [mm]

up to 38⁴⁾ (K)
clamping hub diameter

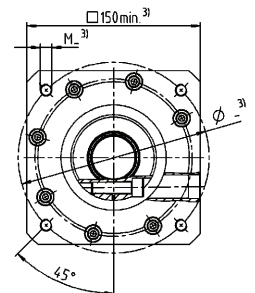
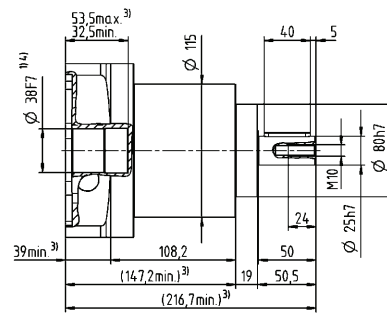
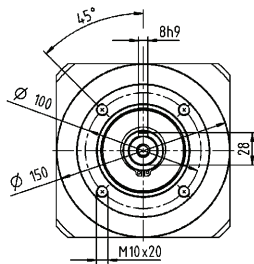

Other output variants

Smooth shaft

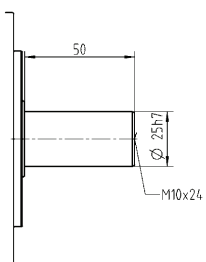

Replaceable B5 output flange

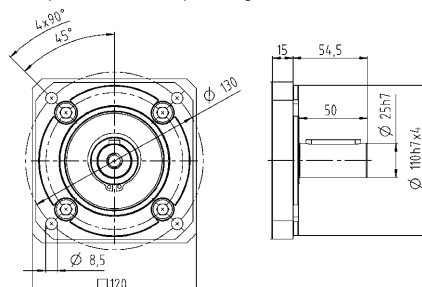

Non-tolerated dimensions are nominal dimensions

¹⁾ Check motor shaft fit

²⁾ Min. / Max. permissible motor shaft length

Longer motor shafts are possible, please contact alpha

³⁾ The dimensions depend on the motor

⁴⁾ Smaller motor shaft diameter is compensated by a bushing with a minimum thickness of 1 mm

⁵⁾ Standard clamping hub diameter

Basic Line gearbox overview



Product type		CP	CPS	CPK	CPSK	CVH	CVS
Version		MF	MF	MF	MF	MF / MT	MF / MT
Catalog pages		22	40	56	74	92	98
Ratio ^{c)}	min. $i =$	3	3	3	3	7	7
	max. $i =$	100	100	100	100	40	40
Max. torsional backlash [arcmin] ^{c)}	Standard	≤ 12	≤ 12	≤ 13	≤ 15	≤ 15	≤ 15
	Reduced	–	–	–	–	–	–
Output type							
Smooth shaft		x	x	x	x	–	x
Shaft with key ^{d)}		x	x	x	x	–	x
Splined shaft (DIN 5480)		–	–	–	–	–	–
Blind hollow shaft		–	–	–	–	–	–
Hollow shaft interface		–	–	–	–	x	–
Keyed hollow shaft		–	–	–	–	x	–
Flanged hollow shaft		–	–	–	–	–	–
Flange		–	–	–	–	–	–
System output		–	–	–	–	–	–
Output on both sides		–	–	–	–	x	x
Input type							
Motor-mounted		x	x	x	x	x	x
Self-contained version ^{b)}		–	–	–	–	–	–
Characteristic							
Flange with slotted holes		–	–	–	–	–	–
ATEX ^{a)}		–	–	–	–	–	–
Food-grade lubrication ^{a) b)}		x	x	x	x	x	x
Corrosion resistant ^{a) b)}		–	–	–	–	–	–
Optimized mass inertia ^{a)}		–	–	–	–	–	–
System solutions							
Linear system (rack/pinion)		–	–	–	–	–	–
Servo actuator		–	–	–	–	–	–
Accessories (please refer to the product pages for further options)							
Coupling		x	x	x	x	–	x
Shrink disc		–	–	–	–	x	–
Mounting ring		–	–	–	–	–	–

^{a)} Power reduction: technical data available on request

^{b)} Please contact WITTENSTEIN alpha

^{c)} In relation to reference sizes

^{d)} Power reduction: Please use our sizing software cymex[®] for a detailed sizing – www.wittenstein-cymex.com

Value Line gearbox overview



Product type		NP	NPL	NPS	NPT	NPR	NPK	NPLK	NPSK	NPTK	NPRK	NVH	NVS	HDV
Version		MF / MA	MF / MA	MF / MA	MF / MA	MF / MA	MF	MF	MF	MF	MF	MF	MF	MF / MT
Catalog pages		110	134	154	174	198	222	238	252	266	282	300	306	316
Ratio ^{d)}	min. $i =$	3	3	3	3	3	3	3	3	3	3	4	4	4
	max. $i =$	100	100	100	100	100	100	100	100	100	100	400	400	400
Max. torsional backlash [arcmin] ^{e)}	Standard	≤ 8	≤ 8	≤ 8	≤ 8	≤ 8	≤ 11	≤ 11	≤ 11	≤ 11	≤ 11	≤ 6	≤ 6	≤ 10
	Reduced	-	-	-	-	-	-	-	-	-	-	-	-	-
Output type														
Smooth shaft		x	x	x	-	x	x	x	x	-	x	-	x	x
Shaft with key ^{d)}		x	x	x	-	x	x	x	x	-	x	-	x	x
Splined shaft (DIN 5480)		-	x	x	-	x	-	x	x	-	x	-	-	-
Blind hollow shaft		-	-	-	-	-	-	-	-	-	-	-	-	-
Hollow shaft interface		-	-	-	-	-	-	-	-	-	-	x	-	-
Keyed hollow shaft		-	-	-	-	-	-	-	-	-	-	x	-	-
Flanged hollow shaft		-	-	-	-	-	-	-	-	-	-	-	-	-
Flange		-	-	-	x	-	-	-	-	x	-	-	-	-
System output		-	-	-	-	-	-	-	-	-	-	-	-	-
Output on both sides		-	-	-	-	-	-	-	-	-	-	x	x	-
Input type														
Motor-mounted		x	x	x	x	x	x	x	x	x	x	x	x	x
Self-contained version ^{b)}		-	-	-	-	-	-	-	-	-	-	-	-	-
Characteristic														
Flange with slotted holes		-	-	-	-	x	-	-	-	-	x	-	-	-
ATEX ^{a)}		-	-	-	-	-	-	-	-	-	-	-	-	-
Food-grade lubrication ^{a) b)}		x	x	x	x	x	x	x	x	x	x	x	x	x
Corrosion resistant ^{a) b)}		-	-	-	-	-	-	-	-	-	-	x	x	x
Optimized mass inertia ^{a)}		-	-	-	-	-	-	-	-	-	-	-	-	-
System solutions														
Linear system (rack/pinion)		x	x	x	-	x	x	x	x	-	x	-	x	-
Servo actuator		-	-	-	-	-	-	-	-	-	-	-	-	x
Accessories (please refer to the product pages for further options)														
Coupling		x	x	x	-	x	x	x	x	-	x	-	x	-
Shrink disc		-	-	-	-	-	-	-	-	-	-	x	-	-
Mounting ring		-	-	-	-	-	-	-	-	-	-	-	-	-

^{a)} Power reduction: technical data available on request

^{b)} Please contact WITTENSTEIN alpha

^{c)} In relation to reference sizes

^{d)} Power reduction: Please use our sizing software cymex® for a detailed sizing – www.wittenstein-cymex.com

Advanced Line gearbox overview



Product type		SP+	SP+ HIGH SPEED	SP+ HIGH SPEED friction optimized	TP+	TP+ HIGH TORQUE	HG+	SK+	SPK+
Version		MF	MC	MC-L	MF	MA	MF	MF	MF
Ratio ^{c)}	min. $i =$	3	3	3	4	22	3	3	12
	max. $i =$	100	100	10	100	302.5	100	100	10000
Max. torsional backlash [arcmin] ^{c)}	Standard	≤ 3	≤ 4	≤ 4	≤ 3	≤ 1	≤ 4	≤ 4	≤ 4
	Reduced	≤ 1	≤ 2	≤ 2	≤ 1	–	–	–	≤ 2
Output type									
Smooth shaft		x	x	x	–	–	–	x	x
Shaft with key ^{d)}		x	x	x	–	–	–	x	x
Splined shaft (DIN 5480)		x	x	x	–	–	–	x	x
Blind hollow shaft		x	x	x	–	–	–	–	x
Hollow shaft interface		–	–	–	–	–	x	–	–
Keyed hollow shaft		–	–	–	–	–	–	–	–
Flanged hollow shaft		–	–	–	–	–	–	–	–
Flange		–	–	–	x	x	–	–	–
System output		–	–	–	x	x	–	–	–
Output on both sides		–	–	–	–	–	x	x	x
Input type									
Motor-mounted		x	x	x	x	x	x	x	x
Self-contained version ^{b)}		x	–	–	x	–	–	–	–
Characteristic									
Flange with slotted holes		x	–	–	–	–	–	–	–
ATEX ^{a)}		x	x	–	–	–	x	x	–
Food-grade lubrication ^{a) b)}		x	x	x	x	x	x	x	x
Corrosion resistant ^{a) b)}		x	x	x	x	x	x	x	x
Optimized mass inertia ^{a)}		x	x	x	x	x	–	–	–
System solutions									
Linear system (rack/pinion)		x	x	–	x	x	–	x	x
Servo actuator		x	–	–	x	x	–	–	–
Accessories (please refer to the product pages for further options)									
Coupling		x	x	x	x	x	–	x	x
Shrink disc		x	x	x	–	–	x	–	x
Mounting ring		–	–	–	x	x	–	–	–

^{a)} Power reduction: technical data available on request

^{b)} Please contact WITTENSTEIN alpha

^{c)} In relation to reference sizes

^{d)} Power reduction: Please use our sizing software cymex® for a detailed sizing – www.wittenstein-cymex.com



TK+	TPK+	TPK+ HIGH TORQUE	SC+	SPC+	TPC+	VH+	VS+	VT+	DP+	HDP+
MF	MF	MA	MF	MF	MF	MF	MF	MF	MF / MA	MA
3	12	66	1	4	4	4	4	4	16	22
100	10000	5500	2	20	20	400	400	400	55	55
≤ 4	≤ 4	≤ 1.3	≤ 4	≤ 4	≤ 4	≤ 3	≤ 3	≤ 3	≤ 3	≤ 1
-	≤ 2	-	-	≤ 2	≤ 2	≤ 2	≤ 2	≤ 2	≤ 1	-

-	-	-	x	x	-	-	x	-	-	-
-	-	-	x	x	-	-	x	-	-	-
-	-	-	-	x	-	-	x	-	-	-
-	-	-	-	x	-	-	-	-	-	-
-	-	-	-	-	-	x	-	-	-	-
-	-	-	-	-	-	x	-	-	-	-
x	-	-	-	-	-	-	-	x	-	-
-	x	x	-	-	x	-	-	-	x	x
-	x	x	-	-	x	-	-	-	-	-
x	x	x	-	-	-	x	x	-	-	-

x	x	x	x	x	x	x	x	x	x	x
-	-	-	-	-	-	-	-	-	-	-

-	-	-	-	-	-	-	-	-	-	-
x	-	-	-	-	-	-	-	-	-	-
x	x	x	x	x	x	x	x	x	x	x
x	x	x	-	-	-	x	x	x	x	x
-	-	-	-	-	-	-	-	-	x	x

x	x	x	x	x	x	-	x	x	-	-
-	-	-	-	-	-	-	-	-	-	-

x	x	x	x	x	x	-	x	x	-	-
-	-	-	-	x	-	x	-	-	-	-
-	-	-	-	-	-	-	-	-	x	-

Premium Line gearbox overview



Product type		XP+	RP+	XPK+	RPK+	XPC+	RPC+
Version		MF / MC	MF / MA	MF	MA	MF	MA
Ratio ^{c)}	min. $i =$	3	22	12	48	4	22
	max. $i =$	100	220	1000	5500	20	55
Max. torsional backlash [arcmin] ^{c)}	Standard	≤ 3	≤ 1	≤ 4	≤ 1.3	≤ 4	≤ 1.3
	Reduced	≤ 1	–	≤ 2	–	≤ 2	–
Output type							
Smooth shaft		x	–	x	–	x	–
Shaft with key ^{d)}		x	–	x	–	x	–
Splined shaft (DIN 5480)		x	–	x	–	x	–
Blind hollow shaft		x	–	x	–	x	–
Hollow shaft interface		–	–	–	–	–	–
Keyed hollow shaft		–	–	–	–	–	–
Flanged hollow shaft		–	–	–	–	–	–
Flange		–	x	–	x	–	x
System output		x	x	x	x	x	x
Output on both sides		–	–	–	–	–	–
Input type							
Motor-mounted		x	x	x	x	x	x
Self-contained version ^{b)}		x	–	–	–	–	–
Characteristic							
Flange with slotted holes		x	x	x	x	x	x
ATEX ^{a)}		–	–	–	–	–	–
Food-grade lubrication ^{a) b)}		x	x	x	x	x	x
Corrosion resistant ^{a) b)}		–	–	–	–	–	–
Optimized mass inertia ^{a)}		x	x	–	–	–	–
System solutions							
Linear system (rack/pinion)		x	x	x	x	x	x
Servo actuator		x	x	–	–	–	–
Accessories (please refer to the product pages for further options)							
Coupling		x	–	x	–	x	–
Shrink disc		x	–	x	–	x	–
Mounting ring		–	–	–	–	–	–

^{a)} Power reduction: technical data available on request

^{b)} Please contact WITTENSTEIN alpha

^{c)} In relation to reference sizes

^{d)} Power reduction: Please use our sizing software cymex[®] for a detailed sizing – www.wittenstein-cymex.com

Servo actuator overview



Product type		PBG	PAG	PHG	RPM ^a	TPM ⁺ DYNAMIC	TPM ⁺ HIGH TORQUE	TPM ⁺ POWER
Version		Standard	Standard	Standard	Customer specific	Standard	Standard	Standard
Ratio ^c	min. $i =$	16	16	16	22	16	22	4
	max. $i =$	100	100	100	220	91	220	100
Max. torsional backlash ^c [arcmin]	Standard	≤ 6	≤ 3	≤ 3	≤ 1	≤ 3	≤ 1	≤ 3
	Reduced	≤ 3	≤ 1	≤ 1	–	≤ 1	≤ 1	≤ 1
Output shape								
Smooth shaft		x	–	x	–	–	–	–
Shaft with key ^d		x	–	x	–	–	–	–
Splined shaft (DIN 5480)		x	–	x	–	–	–	–
Blind hollow shaft		–	–	–	–	–	–	–
Hollow shaft interface		–	–	–	–	–	–	–
Keyed hollow shaft		–	–	–	–	–	–	–
Flanged hollow shaft		–	–	–	–	–	–	–
Flange		–	x	–	x	x	x	x
System output		–	x	x	x	x	x	x
Output on both sides		–	–	–	–	–	–	–
Input type								
Motor-mounted		–	–	–	–	–	–	–
Self-contained version		–	–	–	–	–	–	–
Characteristic								
Flange with slotted holes		x	–	x	x	–	–	–
ATEX ^{a)}		–	–	–	–	–	–	–
Food-grade lubrication ^{a) b)}		x	x	x	x	x	x	x
Corrosion resistant ^{a) b)}		–	–	–	–	x	x	x
Optimized mass Inertia ^{a)}		–	–	–	–	–	–	–
System solutions								
Linear system (rack / pinion)		x	x	x	x	x	x	x
Accessories (please refer to the product pages for further options)								
Coupling		x	x	x	–	x	x	x
Shrink disc		x	–	–	–	–	–	–
Power cable, signal cable, hybrid cable		x	x	x	x	x	x	x

^{a)} Power reduction: technical data available on request

^{b)} Please contact WITTENSTEIN alpha

^{c)} In relation to reference sizes

^{d)} Power reduction: Please use our sizing software cymex[®] for a detailed sizing – www.wittenstein-cymex.com

Value Linear Systems

System solutions count

The Value Linear Systems are adapted to linear applications in the Value Segment with comparatively low requirements in terms of smooth running, positioning accuracy, and feed force. The systems are typically used in woodworking machinery, plasma cutting systems, and automation.

High-end technology – the R-flange

The R-flange adapted from the Premium Segment allows greater design freedom in the Value Segment. The gearbox flange with integrated slots enables easy positioning of the gearbox with mounted pinion in relation to the rack. Cumber- some solutions with complicated designs featuring intermedi- ate plates are therefore not required.

The alpha preferred Linear System

Our preferred Linear Systems in the Value Segment are the ideal combination of gearbox, pinion, rack, and lubrica- tion system. The systems have been optimized to achieve the required feed force, feed speed, stiffness, and deg- ree of utilization of the individual components. They cover a feed force range of up to 8,000 N. Feed speeds of up to 400 m/min are possible.



Refer to our alpha Linear Systems catalog and the website for more information on the Value, Advanced, and Premium Linear System.

www.wittenstein-alpha.com/linear-systems

For a wide range of applications

alpha Linear Systems are suitable for a wide range of applica- tions and industries. New standards are being set in the fol- lowing areas:

- Smooth running
- Positioning accuracy
- Feed force
- Power density
- Rigidity
- Ease of installation
- Structural design
- Scalability

Paired with a comprehensive range of services, we support you from the constructional draft to sizing, assembly, and commis- sioning. We will also ensure a consistent supply of spare parts.

The benefits of the alpha Linear Systems for you

- Perfectly matched components
- Maximum efficiency and power density
- Exceptional Linear System rigidity for even greater dynamics and precision
- Simple mounting and perfect integration in the drive train
- Available in different sizes, power categories, and segments

Consultation and quality – everything from a single source!

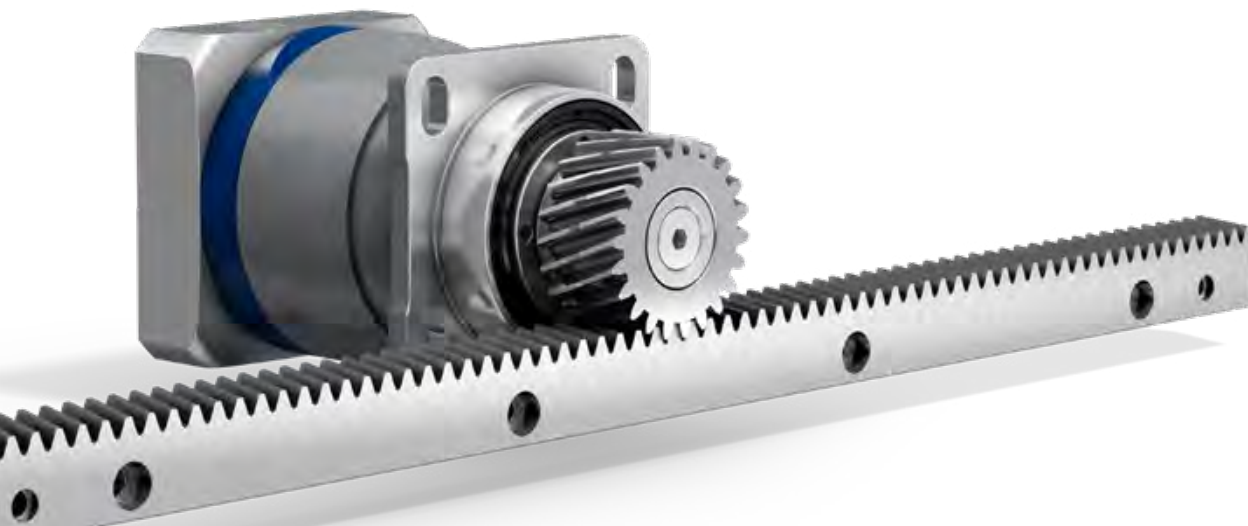

premo – servo actuators by WITTENSTEIN alpha

premo is the new, powerful servo actuator platform that combines absolute precision with perfect movement. The central idea behind this first fully scalable servo actuator platform is uncompromising flexibility from the viewpoint of the user: motors and gearboxes with application-related graduated performance characteristics can be configured modularly into individual servo actuators. The result is a highly versatile modular system with customizable power, designed for a wide range of applications. The core of the servo actuator is a torsionally rigid precision gearbox with low backlash and excellent torque density combined with the equally powerful, permanent magnet servo motor with an evenly distributed winding that guarantees low cogging and high speed constancy.

Typical areas of application and industry solutions

- Delta robot (axes 1–3, swivel axis)
- Handling gantry (Z-axis, swivel/rotating axis)
- Machine tool milling (rotating axes A–C, tool changer)
- Fill and seal machine (incl. jaw stroke, sealing jaw, blade)
- Folding carton packaging (incl. assembly/folding, filling valve)
- Plastic thermoform (tool axis)

premo application examples

premo PRODUCT HIGHLIGHTS

- Optimized power density for greater energy efficiency and productivity
- Flexible mechanical and electrical interfaces for high scalability
- Individual upgrading of the basic configuration through a variety of options



Handling gantry
premo SP Line



Fill and seal machine
premo TP Line



Milling head of a
machining center
premo XP Line

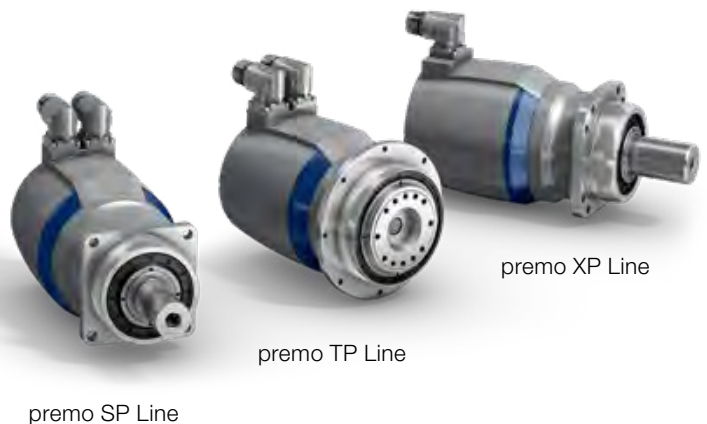
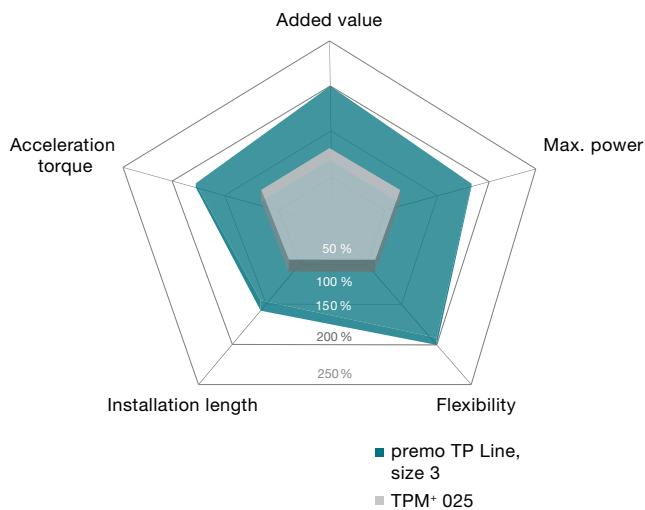

premo SP Line

premo TP Line

premo XP Line

Accessories – smart addition of intelligent performance

In addition to gearboxes, servo actuators, and linear systems, we offer our customers an extensive portfolio of matching accessories.

Shrink discs and couplings are primarily used in the Basic and Value Line. Shrink discs are mainly

used in applications with hollow shafts and couplings in shaft connections.

Perfectly match with the gearbox, they meet the expectations of customers.

Gearboxes, accessories, and consultation from a single source

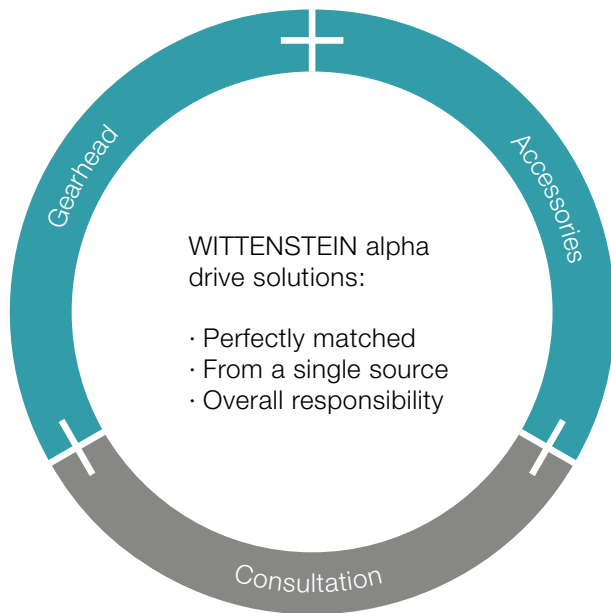

Optimization of your value creation chain

Use the combination of gearboxes and accessories in a complete package to streamline your internal processes.

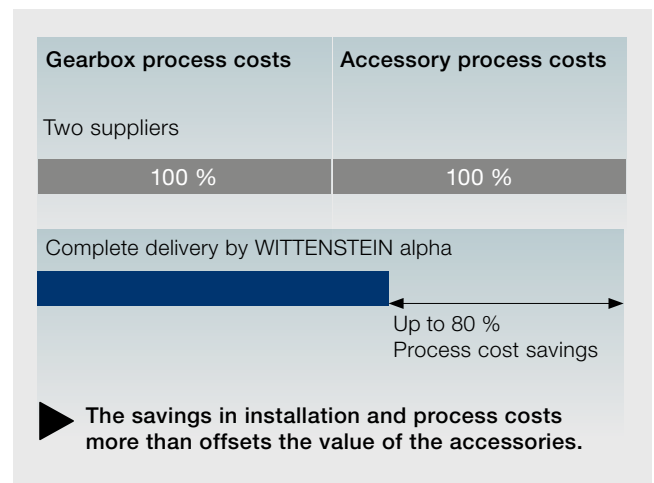

Shrink discs

Shrink discs are frictional hub-shaft connections. Together with our hollow shaft or blind hollow shaft gearboxes for direct mounting to load shafts, machine designs with a minimal installation space can be realized.

The benefits:

- Simple assembly and disassembly
- Corrosion-resistant stainless steel version
- Maximum safety during the transmission of the emergency stop torques

Preferred shrink disc series

Provided it is possible to mount a shrink disc, you will find the matching shrink discs on the product page for your selected gearbox. To view more nickel-plated, stainless steel, and other shrink discs as well as all the relevant technical data and dimensions, visit our homepage

www.wittenstein-alpha.com



Couplings

Our innovative couplings, which are used in various drive technology sectors, ensure efficiency and process reliability in the applications.

Our couplings have the following properties:

- Completely backlash-free torque transmission
- Maintenance free
- Durable
- Compensation of shaft misalignments (axial, angular, lateral)

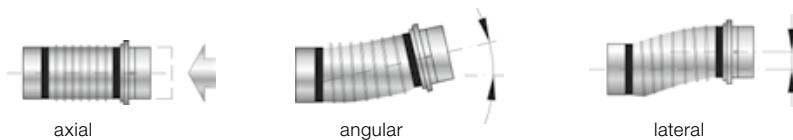

Metal bellows coupling

- High torsional rigidity
- Minimal reset forces
- High true-running accuracy
- Corrosion resistant version available as an option (BC2, BC3, BCT)
- Large temperature range
-30 °C to +300 °C
- Preferred coupling for alpha Advanced Line and alpha Premium Line

alpha Premium

alpha Advanced



Elastomer coupling

- Choice of torsional rigid/damping
- Compact, plug-in design
- Extremely easy assembly
- Temperature range -30 °C to +120 °C
- Preferred coupling for alpha Basic Line and alpha Value Line

alpha Value

alpha Basic



Torque limiter

- Torque infinitely adjustable
- Easy to assemble
- Precise repeatability
- Precise, preset overload protection (switch-off in 1–3 ms)

Suitable for all alpha gearbox series

Preferred coupling series

The technical dimensional sheets for the gearboxes include a preselection of couplings. These are based on the maximum transmittable torque of the gearbox. Standard industrial conditions for the number of cycles (1,000/h) and ambient temperature were adopted.

Please note that the coupling load is based on the torque the gearbox can transmit and not the torque in your application. For a detailed sizing we recommend using our cymex®5 design software.

You can find detailed information about our couplings at www.wittenstein-alpha.com

Support at each interaction stage

With the WITTENSTEIN alpha service concept, we are also setting new standards in the field of customer support.

DESIGN



We offer the right sizing methodology for every requirement. Whether easy downloading of CAD data, quick and easy calculation, or precise sizing of the drive train.

STARTUP



Our service experts are happy to support you in the installation and startup of complex mechatronic systems, guaranteeing maximum availability of your plant.

SERVICING



WITTENSTEIN alpha guarantees fast repairs of the highest quality and precision. In addition, we will provide you with information about various measurements, material analyses, and condition monitoring inspections.



Consultation

- Personal contact on site
- Competent application calculations and drive sizing

Engineering

Catalog gearboxes:

- Advanced software tools for accurate calculation, simulation, and analysis of the drive train
- Optimization of your productivity

Special gearboxes:

- Development and production of customized gearboxes
- Gearing design and development
- Inquiries: sondergetriebe@wittenstein.de



CAD POINT
YOUR SMART CATALOG



SIZING ASSISTANT
YOUR GEARBOX WITHIN SECONDS



cymex[®] 5
CALCULATE ON THE BEST

See pages 12–15 for more information about the software tools



speedline[®] delivery

Tel. +49 7931 493-10444

- Delivery of standard product range in 24 or 48 hours ex works*
- Fast deliveries at short notice

Installation on site

- Professional installation
- Optimal application integration
- Introduction to the operation of the drive

Operating and installation instructions

- Detail description of how to use the product
- Installation and motor mounting videos

Pick-up & return service

- Minimization of downtimes
- Professional logistics organization
- Reduction of transport risks

* Non-binding delivery time depending on part availability



24 h service hotline

Tel. +49 7931 493-12900

Maintenance and inspection

- Documentation regarding condition and expected service life
- Customer-specific maintenance schedules

Repairs

- Repair to nominal condition
- Immediate response in time-critical situations

cymex[®] statistics

- Systematic field data acquisition
- Reliability calculations (MTBF)

Modernization

- Professional retrofitting
- Reliable compatibility testing of existing solutions



Individual training without limits

All delivered products are perfectly matched to your application environment and immediately 100 % operational.

Our service experts support you in the commissioning of complex mechatronic systems, guaranteeing maximum availability of your plant.

Product training

Greater knowledge enables greater achievement. We will be pleased to share our expert knowledge with you: Profit from our many years of experience and learn more about the product portfolio of WITTENSTEIN alpha.

Installation training

We offer you individual training courses on-site for your system application of selected linear axes as well as professional installation.

Sizing training

Become a design expert! We will provide you with training courses on our design software, adapted to your requirements. Whether for beginners or experts, for occasional or regular users – we adapt our training course to your wishes and requirements.

Service training

Participation in a service training course is a prerequisite for sourcing spare parts at the parts list level. We offer you training courses at our premises or on-site at your plant. Moreover, we regularly host maintenance workshops at which the participants are instructed in safe handling during mounting of the motor to the gearbox as well as the independent replacement of wearing parts and gearbox assemblies.

Global presence. Personal consultation.

No matter where you need us:

A comprehensive sales and service network provides quick availability and competent support worldwide.

24 h service hotline: +49 7931 493-12900



The WITTENSTEIN group – The company and its fields of business

With approximately 2,900 employees worldwide, WITTENSTEIN SE stands for innovation, precision and excellence in the world of mechatronic drive technology, both nationally and internationally. The group is active in seven innovative fields of business.

Furthermore, WITTENSTEIN SE is represented by some 60 subsidiaries in around 40 countries in all important technology and sales markets worldwide.

Our fields of expertise

- Machine and plant construction
- Software development
- Aerospace
- Automotive & E-mobility
- Energy
- Oil & Gas Exploration
- Medical technology
- Measurement and testing technology
- Nanotechnology
- Simulation



WITTENSTEIN

The WITTENSTEIN Group



WITTENSTEIN alpha GmbH
High-precision servo drives and linear systems



WITTENSTEIN cyber motor GmbH
Highly dynamic servo motors and drive electronics



WITTENSTEIN galaxie GmbH
Superior gearboxes and drive systems

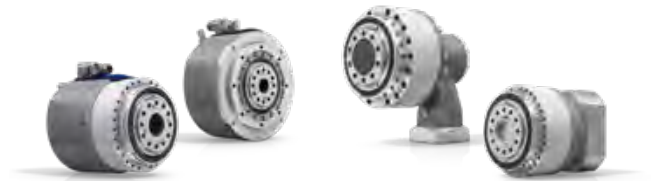

WITTENSTEIN motion control GmbH
Customized linear and rotary servo systems



WITTENSTEIN aerospace & simulation GmbH
Mechatronic drive systems for aerospace & simulation



attocube systems AG
Nanoprecision drive and measurement technology solutions



baramundi software AG
Secure management of IT infrastructure in offices and production areas



Product portfolio & company

WITTENSTEIN – one with the future

www.wittenstein.de

Sizing – Planetary / Bevel gearboxes

The following schematic shows the steps of the sizing of planetary and bevel gearboxes.
Please use cymex® - www.wittenstein-cymex.com for a detailed sizing.

Schematic cyclic operation **S5** and continuous operation **S1**

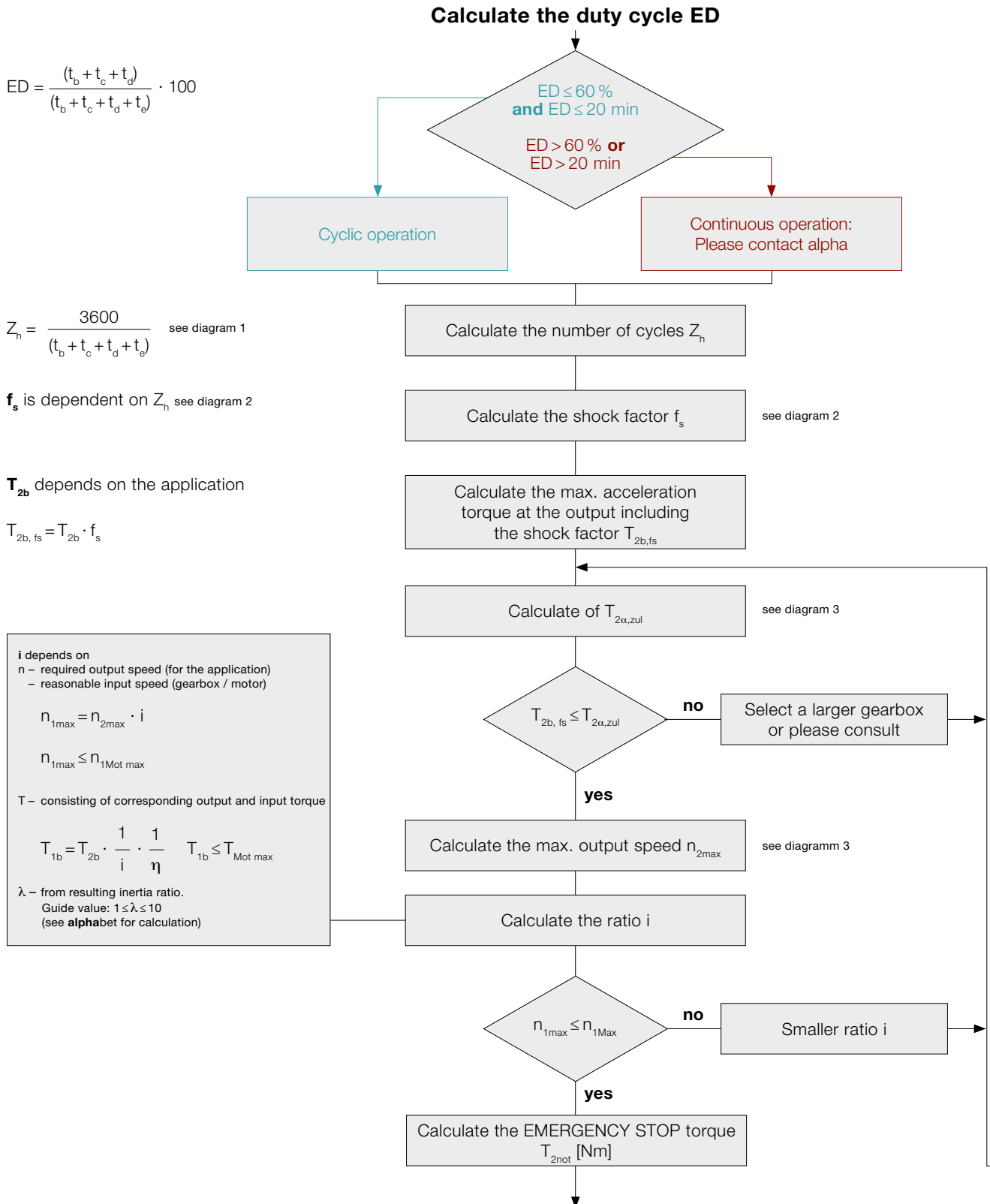

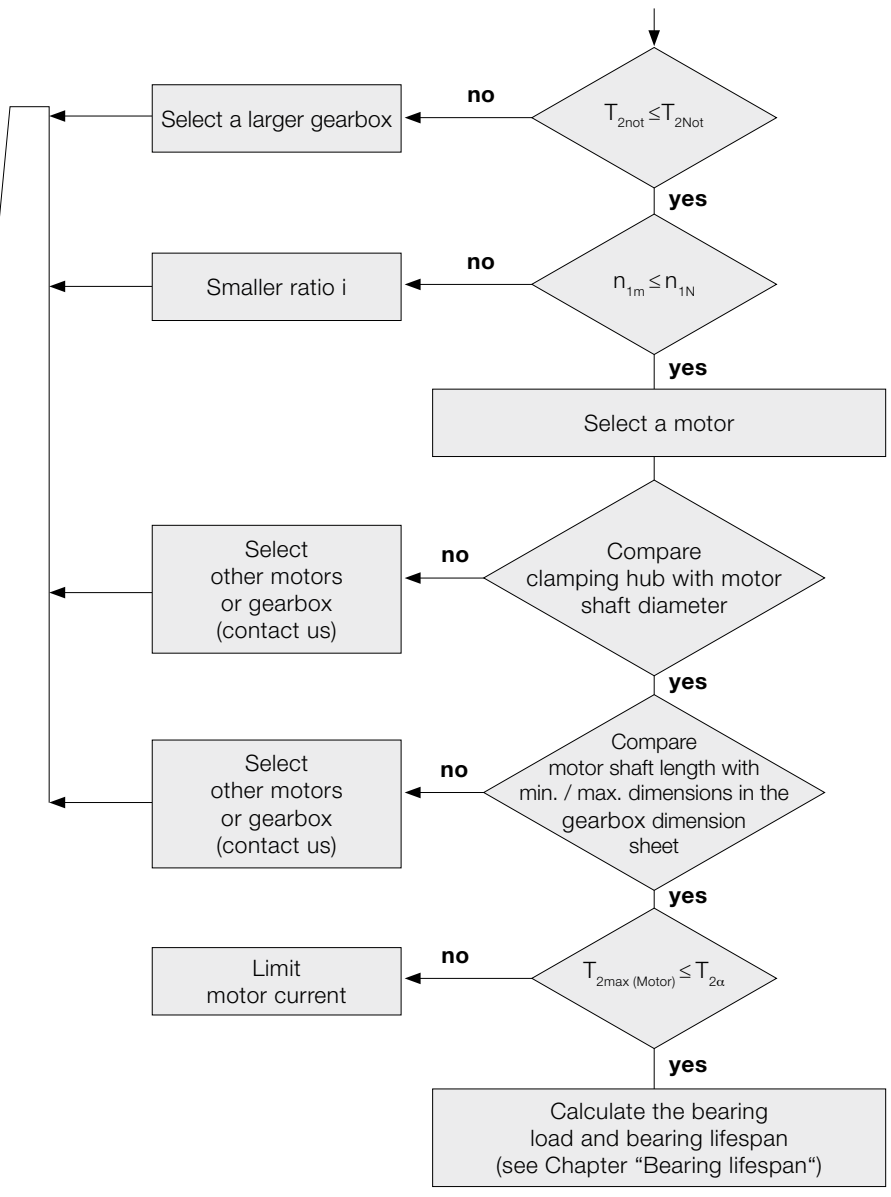

$$D_{W, Mot} \leq D_{clamping\ hub}$$

The motor shaft must be inserted far enough into the clamping hub.

The motor shaft must protrude far enough into the clamping hub without making contact.

The gearbox should not be damaged when the motor operates at full load, limit the motor current if necessary.

Diagram 1
Standard collective load at output. At input speeds up to rated speed n_{1N} or thermal speed limit n_{1T} , the temperature of the gearbox will not exceed 90 °C under average ambient conditions.

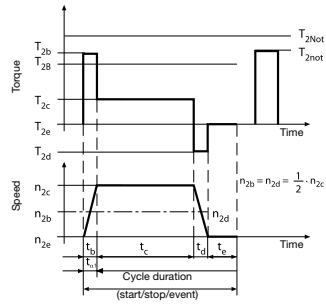

Diagram 2
Large number of cycles combined with short acceleration times may cause the drive train to vibrate. Use the shock factor f_s to include the resulting excess torque values in calculations.

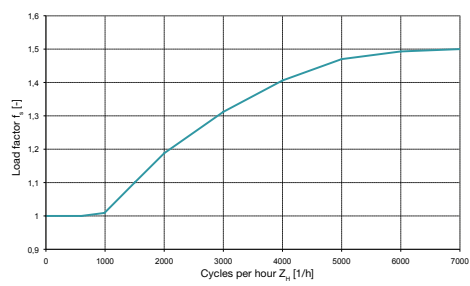
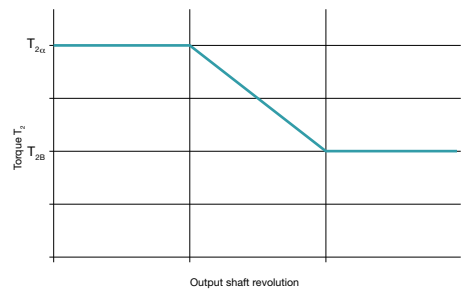

Diagram 3
The transmittable torque $T_{2\alpha, per}$ of the gearbox is dependent on the number of output shaft revolutions. In the lower output shaft revolution range, the fatigue strength range of the toothing can be fully utilized up to the maximum value $T_{2\alpha}$.



Sizing – Planetary / Bevel gearboxes

Please use cymex® - www.wittenstein-cymex.com for a detailed sizing.

Calculation bearing lifespan L_{h10}

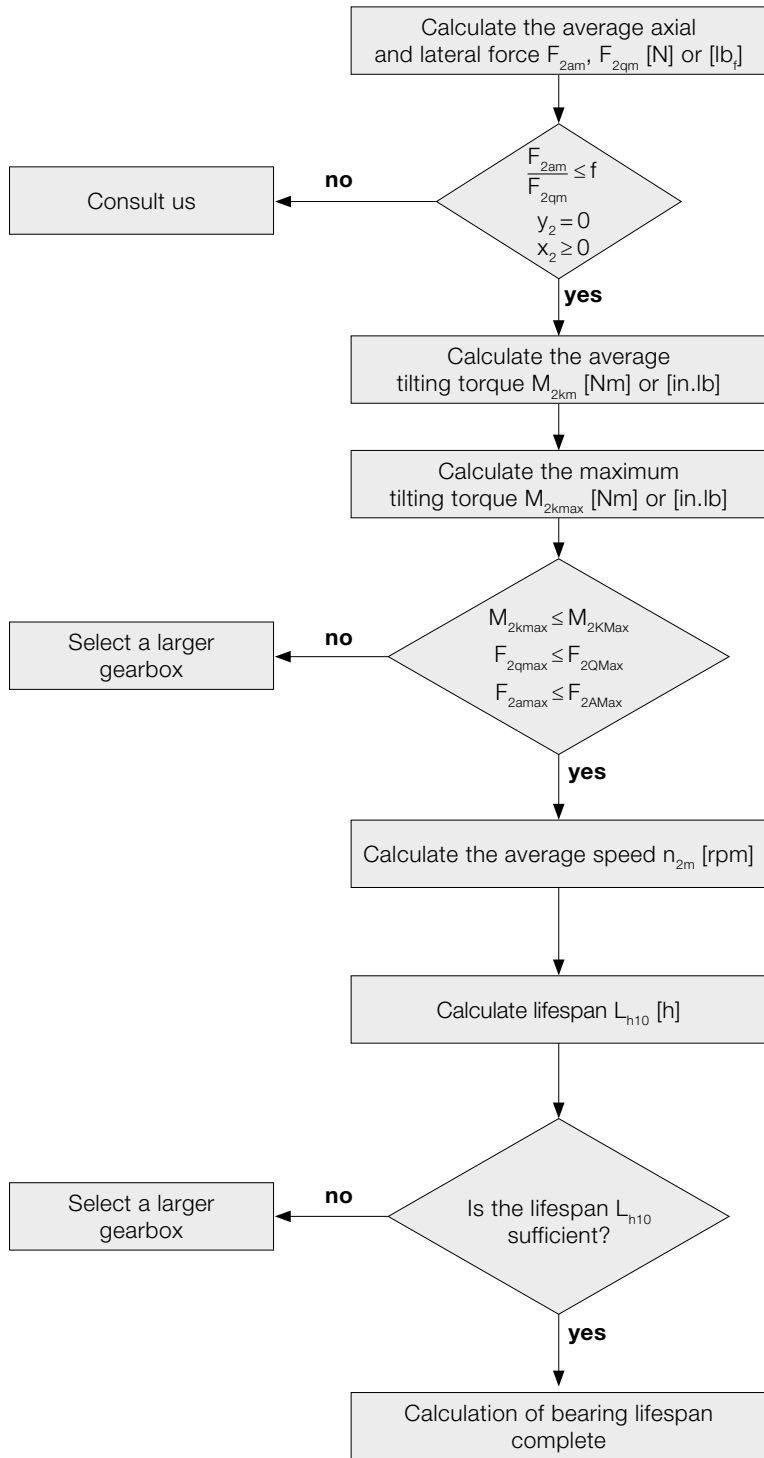

$$F_{2am} = \sqrt[3]{\frac{|n_{2b}| \cdot t_b \cdot |F_{2ab}|^3 + \dots + |n_{2n}| \cdot t_n \cdot |F_{2an}|^3}{|n_{2b}| \cdot t_b + \dots + |n_{2n}| \cdot t_n}}$$

$$F_{2qm} = \sqrt[3]{\frac{|n_{2b}| \cdot t_b \cdot |F_{2qb}|^3 + \dots + |n_{2n}| \cdot t_n \cdot |F_{2qn}|^3}{|n_{2b}| \cdot t_b + \dots + |n_{2n}| \cdot t_n}}$$

$$M_{2km} = \frac{F_{2am} \cdot y_2 + F_{2qm} \cdot (x_2 + z_2)^{a)}}{W}$$

$$M_{2kmax} = \frac{F_{2amax} \cdot y_2 + F_{2qmax} \cdot (x_2 + z_2)^{a)}}{W}$$

a) x, y, z in mm

$$n_{2m} = \frac{n_{2b} \cdot t_b + \dots + n_{2n} \cdot t_n}{t_b + \dots + t_n}$$

$$L_{h10} = \frac{16666}{n_{2m}} \cdot \left[\frac{K1_2}{M_{2km}} \right]^{p_2}$$

	metric
W	1000

	CP / CPS / NP / NPT / HDV CPK / CPSK / NPK / NPTK	NPL / NPS / NPR NPLK / NPSK / NPRK
f	0.24	0.4

CP / CPS CPK / CPSK			005	015	025	035	045
MF	z ₂	[mm]	12.4	19.3	27.7	31.5	47
		[in]	0.49	0.76	1.1	1.2	1.9
	K1 ₂	[Nm]	20	69	238	501	1512
		[in.lb]	177	610	2106	4433	13381
	p ₂		3	3	3	3	3

NP / NPK			005	015	025	035	045
MF / MA	z ₂	[mm]	20	28.5	31	40	47
		[in]	0.79	1.1	1.2	1.6	1.9
	K1 ₂	[Nm]	75	252	314	876	1728
		[in.lb]	663	2230	2778	7752	15292
	p ₂		3	3	3	3	3

NPT / NPTK			005	015	025	035	045
MF / MA	z ₂	[mm]	27.7	34.6	39.3	44.5	58.2
		[in]	1.1	1.4	1.6	1.8	2.3
	K1 ₂	[Nm]	136	211	310	628	995
		[in.lb]	1203	1867	2743	5557	8805
	p ₂		3	3	3	3	3

NPL / NPS / NPR NPLK / NPSK / NPRK			015	025	035	045
MF / MA	z ₂	[mm]	42.2	44.8	50.5	63
		[in]	1.7	1.8	2	2.5
	K1 ₂	[Nm]	795	1109	1894	3854
		[in.lb]	7035	9814	16761	34107
	p ₂		3.33	3.33	3.33	3.33

Example with output shaft and flange:

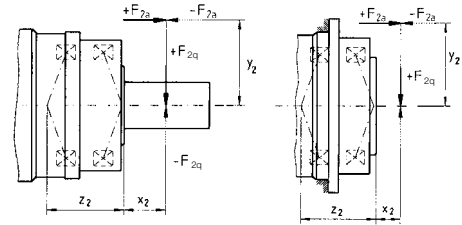

HDV			015	025	035
MF	z ₂	[mm]	41.7	45.65	57.25
		[in]	1.6	1.8	2.3
	K1 ₂	[Nm]	84	131	406
		[in.lb]	743	1159	3593
MT	z ₂	[mm]	53	58.65	74.75
		[in]	2.1	2.3	2.9
	K1 ₂	[Nm]	217	452	1370
		[in.lb]	1920	4000	12125
	p ₂		3	3	3

Calculation tilting moment caused by the motor M_{1kMot}

For NPK, NPSK, NPLK, NPRK, NPTK, CPK, and CPSK

Particularly when the motor is installed in a horizontal mounting position (xx/B5)

Clamping hub diameter	-	mm	11	14	19	28	38
Max. permissible static tilting moment caused by motor	M_{1kMot}	Nm	5.5	7	18	55	130

In horizontal mounting position B5 and symmetrical weight distribution of the motor:

$$M_{1kMot} = \text{motor weight [kg]} \cdot 4,9 \cdot \text{motor length [m]}$$

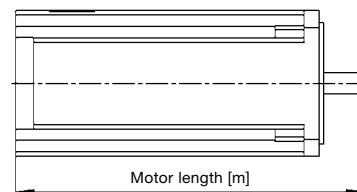

Sizing – Worm gearboxes

The following schematic shows the steps of the sizing of worm gearboxes.
Please use cymex® - www.wittenstein-cymex.com for a detailed sizing.

A: Simplified sizing for servo motors based on the maximum motor torque: $M_{max} * i \leq T_{2\alpha}$

B: Sizing based on the application

Step 1:

Determine the application data

$$T_{2b} = \text{_____ [Nm]} \quad n_{1n} = \text{_____ [rpm]}$$

Step 2:

Determine the operating mode factor $K_M = \text{_____}$

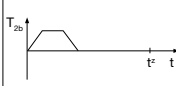
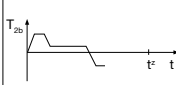
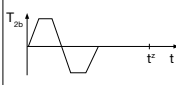
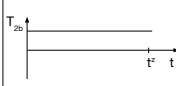
Typical applications	Cycle	Torque characteristic	Operating mode factor K_M
Format changing, e.g. in packaging machines, drives for processing equipment, actuators etc.	S5 operation: Low duty cycle Small number of cycles Low dynamics		1.0
Tool changers with low dynamics, pick & place gantry axes, tire building machines etc.	S5 operation: Medium duty cycle Small number of cycles Medium dynamics		1.6
Linear axes in plasma, laser or water jet cutters, portals, tool changers with high dynamics	S5 operation: Medium duty cycle Medium number of cycles High dynamics		1.9
Roller drives in printing presses, star drives in rackers etc.	S1 operation: High duty cycle		2.2

cymex® 5 also allows sizing calculations for other applications / cycles!

Step 3:

Determine the sizing factor f_a with the operating mode factor K_M $f_a = \text{_____}$

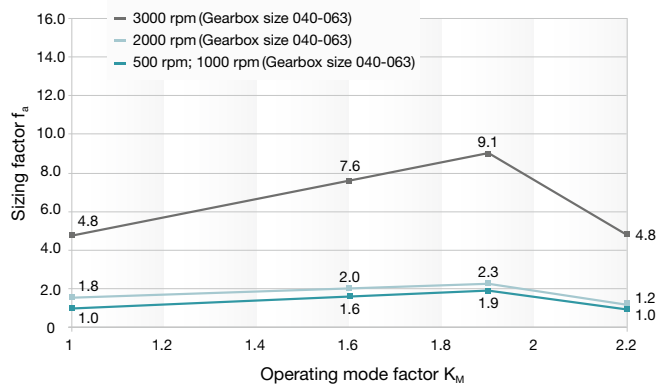

Step 4:

Compare the equivalent application torque with the maximum gearbox $T_{2\alpha}$ (see table, Step 5)

$$T_{2,eq} = f_a * T_{2b} \leq T_{2\alpha}$$

$$T_{2,eq} = \text{_____} * \text{_____} \leq T_{2\alpha}$$

$$T_{2,eq} = \text{_____ [Nm]} \leq \text{_____ [Nm]}$$

We recommend using a vent screw for duty cycles $\geq 60\%$, longer than 20 min (S1 operation) and $n1N \geq 3000$ rpm.

Step 5: Quick selection of the technical data

			V-Drive Basic			V-Drive Value		
			040	050	063	040	050	063
Ratio	i		7-40			4-400		
Max. torque ^{a)} (at $n_1 = 500$ rpm)	T_{2b}	Nm	68-82	116-140	265-301	74-98	150-167	303-365
Max. input speed	n_{1max}	rpm	6000	6000	4500	6000	6000	4500
Max. lateral force	F_{2QMmax}	N	1000 / 2400 ^{b)}	1200 / 3800 ^{b)}	2000 / 6000 ^{b)}	2400	3800	6000
Operating noise	L_{pA}	dB(A)	≤ 54	≤ 62	≤ 64	≤ 54	≤ 62	≤ 64
Max. backlash	j_1	arcmin	≤ 15	≤ 15	≤ 15	≤ 6	≤ 6	≤ 6
Service life	L_n	h	> 15000	> 15000	> 15000	> 20000	> 20000	> 20000

^{a)} The maximum torques depend on the ratio.

^{b)} Refers to center of the output shaft or flange. First value for MF-version (Standard), second value for MT-version (reinforced bearing).

Account must be taken of the lateral and axial forces at the output:

Please also carry out steps 6 and 7 if forces are present at the output (e.g. if timing belt pulleys, pinions or levers are mounted there).

Step 6 (if external forces are present):

Determine the forces acting on the output and check the boundary conditions

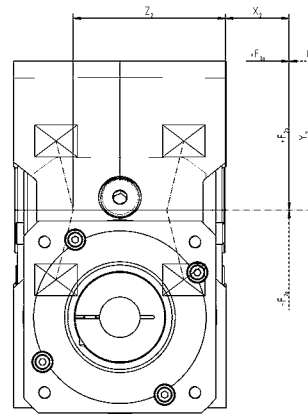

Lateral force $F_{2q} = \underline{\hspace{2cm}}$ [N]
 Lateral force distance $x_2 = \underline{\hspace{2cm}}$ [mm]
 Axial force $F_{2a} = \underline{\hspace{2cm}}$ [N]
 Axial force distance $y_2 = \underline{\hspace{2cm}}$ [mm]
 (required if F_{2a} is present)

Conditions if axial force F_{2a} is present:

1. $F_{2a} \leq 0.25 * F_{2q} \Rightarrow (\underline{\hspace{2cm}} \leq 0.25 * \underline{\hspace{2cm}})$ Met Not met: Sizing with cymex® 5
2. $y_2 \leq x_2 \Rightarrow (\underline{\hspace{2cm}} \leq \underline{\hspace{2cm}})$ Met Not met: Sizing with cymex® 5

Step 7:

Determine the maximum equivalent force acting on the output $F_{2_{eq}}$

$F_{2_{eq}} = F_{2q} + 0.25 * F_{2a} \leq F_{2QMax}$ (F_{2QMax} can be determined from the diagram below)

$F_{2_{eq}} = \underline{\hspace{2cm}} + 0.25 * \underline{\hspace{2cm}} \leq \underline{\hspace{2cm}}$

$F_{2_{eq}} = \underline{\hspace{2cm}}$ [N] \leq $\underline{\hspace{2cm}}$ [N] Met Not met: Sizing with cymex® 5

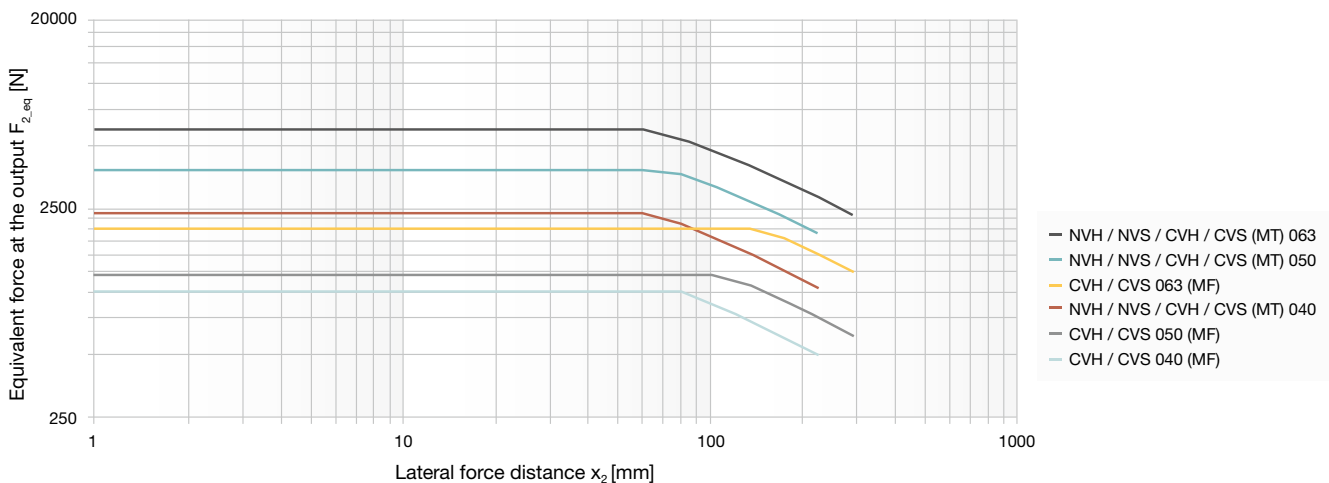

Glossary – the **alphabet**

Acceleration torque (T_{2B})

The acceleration torque T_{2B} is the maximum permissible torque that can briefly be transmitted at the output by the gearhead after $\leq 1000/h$ cycles. For $> 1000/h$ cycles, the \rightarrow **Shock factor** must be taken into account. T_{2B} is the limiting parameter in cyclic operation.

Adapter plate

WITTENSTEIN alpha uses a system of standardized adapter plates to connect the motor and the gearbox, making it possible to mount a WITTENSTEIN alpha gearbox to any desired motor without difficulty.

Angular minute

A degree is subdivided into 60 angular minutes (= 60 arcmin = 60').

Example:

If the torsional backlash is $j_t = 1$ arcmin, the output can be turned $1/60^\circ$. The repercussions for the application are determined by the arc length:

$$b = 2 \cdot \pi \cdot r \cdot \alpha^\circ / 360^\circ.$$

Example:

A pinion with a radius $r = 50$ mm mounted on a gearbox with torsional backlash $j_t = 3$ arcmin can be turned $b = 0.04$ mm.

Axial force (F_{2AMax})

The axial force acting on a gearbox runs parallel to its output shaft or perpendicular to its output shaft. It may be applied with axial offset via a lever arm y_2 under certain circumstances, in which case it also generates a bending moment. If the axial force exceeds the permissible catalog values (max. axial force F_{2AMax}), additional design features (e.g. axial bearings) must be implemented to absorb these forces.

Example with output shaft and flange:

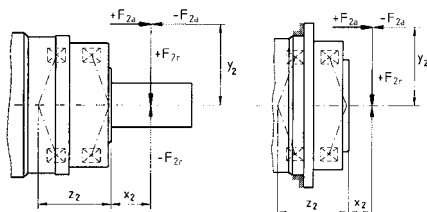

Bushing

If the motor shaft diameter is smaller than the \rightarrow **clamping hub**, a bushing is used to compensate the difference in diameter. The bushing must have a minimum thickness of 1 mm and a motor shaft diameter of 2 mm.

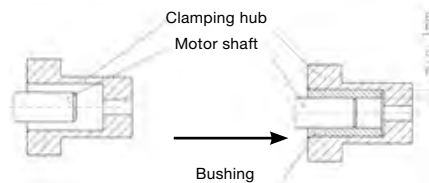

CAD POINT

Performance data, dimension sheets and CAD data for all types of gearbox can be found online in our CAD POINT together with comprehensive documentation of the selection.

(www.wittenstein-cad-point.com)

Clamping hub

The clamping hub ensures a frictional connection between the motor shaft and gearbox. A \rightarrow **bushing** is used as the connecting element if the motor shaft diameter is smaller than that of the clamping hub. Optionally, a positive connection via a parallel key is also possible.

Continuous operation (S1)

Continuous operation is defined by the \rightarrow **duty cycle**. If the duty cycle is greater than 60% and / or longer than 20 minutes, this qualifies as continuous operation. \rightarrow **Operating modes**

Cyclic operation (S5)

Cyclic operation is defined via the \rightarrow **duty cycle**. If the duty cycle is less than 60% and shorter than 20 minutes, it qualifies as cyclic operation (\rightarrow **operating modes**).

cymex®

cymex® is the calculation software developed by our company for dimensioning complete drive trains. The software enables the precise simulation of motion and load variables. The software is available for download from our website (www.wittenstein-cymex.com). We can also provide training to enable you to make full use of all the possibilities provided by the software.

Degree of protection (IP)

The various degrees of protection are defined in DIN EN 60529 "Degrees of protection offered by enclosure (IP code)". The IP degree of protection (International Protection) is represented by two digits. The first digit indicates the protection against the ingress of impurities and the second the protection against the ingress of water.

Example:

IP65

Protection against the ingress of dust (dust-proof)

Protection against spray water

Delivery of speedline®

If necessary, you can receive delivery of standard series in 24 or 48 hours ex works. Outstanding flexibility for fast deliveries at short notice.

Duty cycle (DC)

The cycle determines the duty cycle DC. The times for acceleration (t_a), constant travel if applicable (t_c) and deceleration (t_d) combined yield the duty cycle in minutes. The duty cycle is expressed as a percentage with inclusion of the pause time t_e .

$$DC [\%] = \left[\frac{t_b + t_c + t_d}{t_b + t_c + t_d + t_e} \right] \cdot 100 \frac{\text{Motion duration}}{\text{Cycle duration}}$$

$$DC [\text{min}] = t_b + t_c + t_d$$

Efficiency (η)

Efficiency [%] η is the ratio of output power to input power. Power lost through friction reduces efficiency to less than 1 or 100 %.

$$\eta = P_{\text{off}} / P_{\text{on}} = (P_{\text{on}} - P_{\text{loss}}) / P_{\text{on}}$$

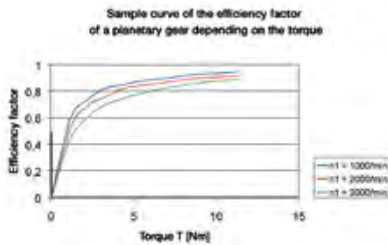

WITTENSTEIN alpha always measures the efficiency of a gearbox during operation at full load. If the input power or torque are lower, the efficiency rating is also lower due to the constant no-load torque. Power losses do not increase as a result. A lower efficiency is also expected at high speeds (see illustration).

Emergency stop torque ($T_{2\text{Not}}$)

The Emergency stop torque $T_{2\text{Not}}$ is the maximum permissible torque at the gearbox output and must not be reached more than 1000 times during the life of the gearbox. It must never be exceeded!

Food-grade lubrication (F)

These products are designed with food-grade lubrication and can therefore be used in the food industry. Note the reduced torques compared to the standard products. (V-Drive excluded). The exact torques can be found in cymex® 5 or CAD POINT.

HIGH TORQUE (MA)

WITTENSTEIN alpha gearboxes are also available in a HIGH TORQUE version. These gearboxes are particularly suited to applications requiring extremely high torques and maximum stiffness.

Hysteresis curve

The hysteresis is measured to determine the torsional rigidity of a gearbox. The result of this measurement is known as the hysteresis curve.

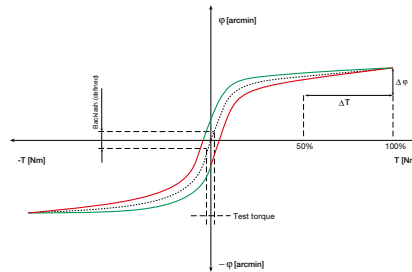

If the input shaft is locked, the gearbox is continuously loaded and relieved at the output in both directions up to a defined torque. The torsional angle is plotted against the torque. This yields a closed curve from which the \rightarrow **torsional backlash** and \rightarrow **torsional rigidity** can be calculated.

Jerk (j)

Jerk is derived from acceleration and is defined as the change in acceleration within a unit of time. The term impact is used if the acceleration curve changes abruptly and the jerk is infinitely large.

Lateral force ($F_{2QM\text{max}}$)

The max. lateral force $F_{2QM\text{max}}$ [Nm] is the force component acting at right angles to the output shaft or parallel to the output flange. It acts perpendicular to the \rightarrow **axial force** and can assume an axial distance of x_2 in relation to the shaft nut or shaft flange, which acts as a lever arm. The lateral force produces a bending moment (see also \rightarrow **axial force**).

Gearboxes of the CP series with size 005 and 015 may be used with higher lateral forces if the T_{2B} is reduced according to the tables below.

CP 005	1-stage					2-stage					
Ratio	4	5	7	10	16	20	25	35	50	70	100
T_{2B}	10.5	11.5	11.5	10.5	10.5	10.5	11.5	11.5	11.5	11.5	10.5
$F_{2QM\text{max}}$	200					200					

CP 015	1-stage					2-stage					
Ratio	4	5	7	10	16	20	25	35	50	70	100
T_{2B}	32	32	32	29	32	32	32	32	32	32	29
$F_{2QM\text{max}}$	650					650					

Mass inertia ratio ($\lambda = \text{Lambda}$)

The mass inertia ratio λ is the ratio of external inertia (application side) to internal inertia (motor and gearbox side). It is an important parameter determining the controllability of an application. Accurate control of dynamic processes becomes more difficult with differing mass moments of inertia and as λ becomes greater. WITTENSTEIN alpha recommends that a guideline value of $\lambda < 5$ is maintained. A gearbox reduces the external mass moment of inertia by a factor of $1/i^2$.

$$\lambda = \frac{J'_{\text{extern}}}{J_{\text{intern}}}$$

J reduced externally at input:

$$J'_{\text{external}} = J_{\text{external}} / i^2$$

Simple applications ≤ 10

Dynamic applications ≤ 5

Highly dynamic applications ≤ 1

Mass moment of inertia (J)

The mass moment of inertia J [kg/cm²] is a measurement of the effort applied by an object to maintain its momentary condition (at rest or moving).

Mesh frequency (f_2)

The mesh frequency may cause problems regarding vibrations in an application, especially if the excitation frequency corresponds to an intrinsic frequency of the application. The mesh frequency can be calculated for planetary gearboxes from WITTENSTEIN alpha (exception: gearboxes with ratio $i = 8$) using the formula $f_2 = 1.8 \cdot n_2$ [rpm].

\rightarrow Refer to this term for further details.

Glossary – the **alphabet**

No-load running torque (T_{012})

The no-load running torque T_{012} is the torque which must be applied to a gearbox in order to overcome the internal friction; it is therefore considered lost torque. The values specified in the catalog are calculated by WITTENSTEIN alpha at a speed of $n_1 = 3000$ rpm and an ambient and gearbox temperature of 20 °C.

T_{012} : 0 1 → 2
 without from input side towards
 load output side

Idling torques decrease during operation.

NSF

Lubricants certified as grade H1 by the NSF (National Sanitation Foundation) can be used in the food sector where occasional unavoidable contact with food cannot be excluded.

Operating modes

(continuous operation **S1** and cyclic operation **S5**)

Gearboxes are selected depending on whether the motion profile is characterized by frequent acceleration and deceleration phases in → **cyclic operation** (S5) as well as pauses, or whether it is designed for → **continuous operation** (S1), i.e. with long phases of constant motion.

Operating noise (L_{PA})

The gear ratio and speed affect the noise level. As a general rule: A higher speed means a higher noise level, while a higher ratio means a lower noise level. The values specified in our catalog are based on a reference ratio and speed. The reference speed is either $n_1 = 3000$ rpm or $n_1 = 2000$ rpm depending on the size of the gearbox. You can find ratio-specific values in cymex® – www.wittenstein-cymex.com.

Output shaft revolution (f_α)

Factor f_α determines the number of cycles for the required gearbox service life. It describes the number of revolutions at the output used to assess the torque permitted at the output.

Positioning accuracy

The positioning accuracy is determined by the angular deviation from a setpoint and equals the sum of the torsional angles due to load → **(torsional rigidity and → torsional backlash)** and kinetics → **(synchronization error)** occurring simultaneously in practise.

Ratio (i)

The gear ratio i indicates the factor by which the gearbox transforms the three relevant parameters of motion (speed, torque and mass moment of inertia). The factor is a result of the geometry of the gearing elements (Example: $i = 10$).

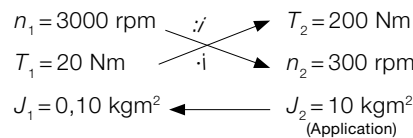

Safety note

For applications with special safety requirements (e.g. vertical axes, clamped drives), we recommend exclusive use of our Premium and Advanced products (excluding V-Drive).

Shock factor (f_s)

The maximum permissible acceleration torque during cyclic operation specified in the catalog applies for a cycle rate less than 1000/h. Higher cycle rates combined with short acceleration times can cause vibrations in the drive train. Use the shock factor f_s to include the resulting excess torque values in calculations. The shock factor f_s can be determined with reference to the curve. This calculated value is multiplied by the actual acceleration torque T_{2b} and then compared with the maximum permissible acceleration torque T_{2B} .
 $(T_{2b} \cdot f_s = T_{2B}, f_s < T_{2B})$

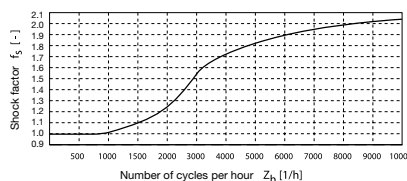

SIZING ASSISTANT

The online SIZING ASSISTANT from WITTENSTEIN alpha allows the efficient selection of a gearbox in seconds. You can use various motor or application entry options to select the right gearbox for your application in seconds (www.sizing-assistant.de).

Speed (n)

Two speeds are of relevance when dimensioning a gearbox: the maximum speed and the thermal speed limit at the input. The maximum permissible speed n_{1Max} must not be exceeded because it serves as the basis for dimensioning → **cyclic operation**. The nominal speed n_{1N} must not be exceeded in → **continuous operation**. The thermal speed limit n_{1T} at an ambient temperature of 20 °C, is determined by the maximum gearbox temperature of $T = 90$ °C at no-load. As can be seen in the diagram below, the temperature limit is reached more quickly in the presence of an elevated outside temperature. In other words: the nominal input speed must be reduced if the ambient temperature is high. The values applicable to your gearbox are available from WITTENSTEIN alpha on request.

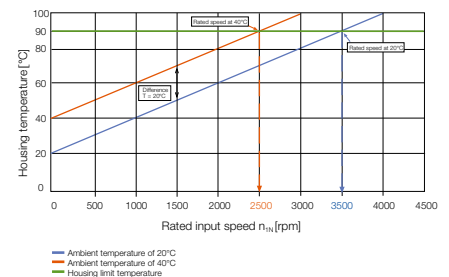

Synchronization

Synchronization refers to the measurable transmission error between the input and output during one revolution of the output shaft.

Technical data

You can download further technical data relating to the entire product portfolio from our website.

Tilting rigidity

The tilting rigidity C_{2K} [Nm/arcmin] of the gearbox consists of the bending stiffness of the output or pinion shaft and the stiffness of the output bearing. It is defined as the quotient of tilting moment M_{2K} [Nm] and tilting angle ϕ [arcmin] ($C_{2K} = M_{2K}/\phi$).

Tilting torque (M_{2K})

The tilting torque M_{2K} is a result of the \rightarrow **axial forces** and \rightarrow **lateral forces** applied and their respective points of application in relation to the inner radial bearing on the output side.

Torsional backlash (j_t)

Torsional backlash j_t [arcmin] is defined as the max. torsional angle of the output shaft at a defined test torque and a blocked input.

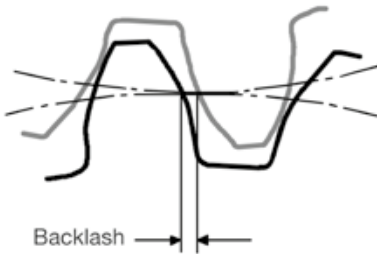

Torsional backlash is measured with the input shaft locked.

The output is then loaded with a defined test torque in order to overcome the internal gearbox friction. The main factor affecting torsional backlash is the face clearance between the gear teeth. The low torsional backlash of WITTENSTEIN alpha gearboxes is due to their high manufacturing accuracy and the specific combination of gear wheels.

Torsional rigidity (C_{t21})

Torsional rigidity [Nm/arcmin] C_{t21} is defined as the quotient of applied torque and resulting torsion angle ($C_{t21} = \Delta T/\Delta\phi$). It shows the torque required to turn the output shaft by one angular minute. The torsional rigidity can be determined from the \rightarrow **hysteresis curve**.

Torsional rigidity C , angle of torsion ϕ

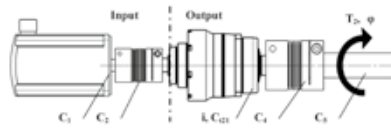

Reduce all torsional rigidity values at the output:

$$C_{(n),out} = C_{(n),in} * i^2$$

with i = Gearbox ratio [-]

$C_{(n)}$ = Individual rigidity values [Nm/arcmin]

Series connection of torsional rigidity values

$$1/C_{tot} = 1/C_{1,out} + 1/C_{2,out} + \dots + 1/C_{(n)}$$

Angle of torsion ϕ [arcmin]

$$\phi = T_2 * 1/C_{tot}$$

with T_2 = output torque [Nm]

Torque (M)

The torque is the actual driving force of a rotary motion. The force and lever arm combine to produce the torque that acts around the axis of rotation. $M = F \cdot l$

Torque ($T_{2\alpha}$)

$T_{2\alpha}$ represents the maximum torque transmitted by the gearbox. This value may decrease depending on the application-specific conditions and the precise evaluation of the movement profile.

Glossary – Formulae

Formulae

Torque [Nm]	$T = J \cdot \alpha$	J = Mass moment of inertia [kgm ²] α = Angular acceleration [1/s ²]
Torque [Nm]	$T = F \cdot l$	F = Force [N] l = Lever, length [m]
Acceleration force [N]	$F_b = m \cdot a$	m = Mass [kg] a = Linear acceleration [m/s ²]
Frictional force [N]	$F_{\text{Reib}} = m \cdot g \cdot \mu$	g = Acceleration due to gravity 9.81 m/s ² μ = Coefficient of friction
Angular speed [1/s]	$\omega = 2 \cdot \pi \cdot n / 60$	n = Speed [U/min] π = PI = 3.14...
Linear speed [m/s]	$v = \omega \cdot r$	r = Radius [m]
Linear speed [m/s] (spindle)	$v_{\text{sp}} = \omega \cdot h / (2 \cdot \pi)$	h = Screw pitch [m]
Linear acceleration [m/s²]	$a = v / t_b$	t_b = Acceleration time [s]
Angular acceleration [1/s²]	$\alpha = \omega / t_b$	
Pinion path [mm]	$s = m_n \cdot z \cdot \pi / \cos \beta$	m_n = Normal module [mm] z = Number of teeth [-] β = Helix angle [°]

Conversion table

1 mm	= 0.039 in
1 Nm	= 8.85 in.lb
1 kgcm²	= 8.85 x 10 ⁻⁴ in.lb.s ²
1 N	= 0.225 lb _f
1 kg	= 2.21 lb _m

Symbol

Symbol	Unit	Designation
C	Nm/arcmin	Stiffness
ED	%, min	Duty cycle
F	N	Force
f_s	–	Load factor
f_e	–	Factor for duty cycle
i	–	Ratio
j	arcmin	Backlash
J	kgm ²	Mass moment of inertia
$K1$	Nm	Factor for bearing calculation
L	h	Service life
L_{PA}	dB(A)	Operating noise
m	kg	Mass
M	Nm	Torque
n	rpm	Speed
p	–	Exponent for bearing calculation
η	%	Efficiency
t	s	Time
T	Nm	Torque
v	m/min	Linear speed
z	1/h	Number of cycles

Index

Index	Designation
Capital letter	Permissible values
Small letter	Actual values
1	Input
2	Output
A/a	Axial
B/b	Acceleration
c	Constant
d	Deceleration
e	Pause
h	Hours
K/k	Tilting
m	Mean
Max/max	Maximum
Mot	Motor
N	Nominal
Not/not	Emergency stop
0	No load
Q/q	Lateral
t	Torsional
T	Tangential

Ordering code – planetary gearboxes

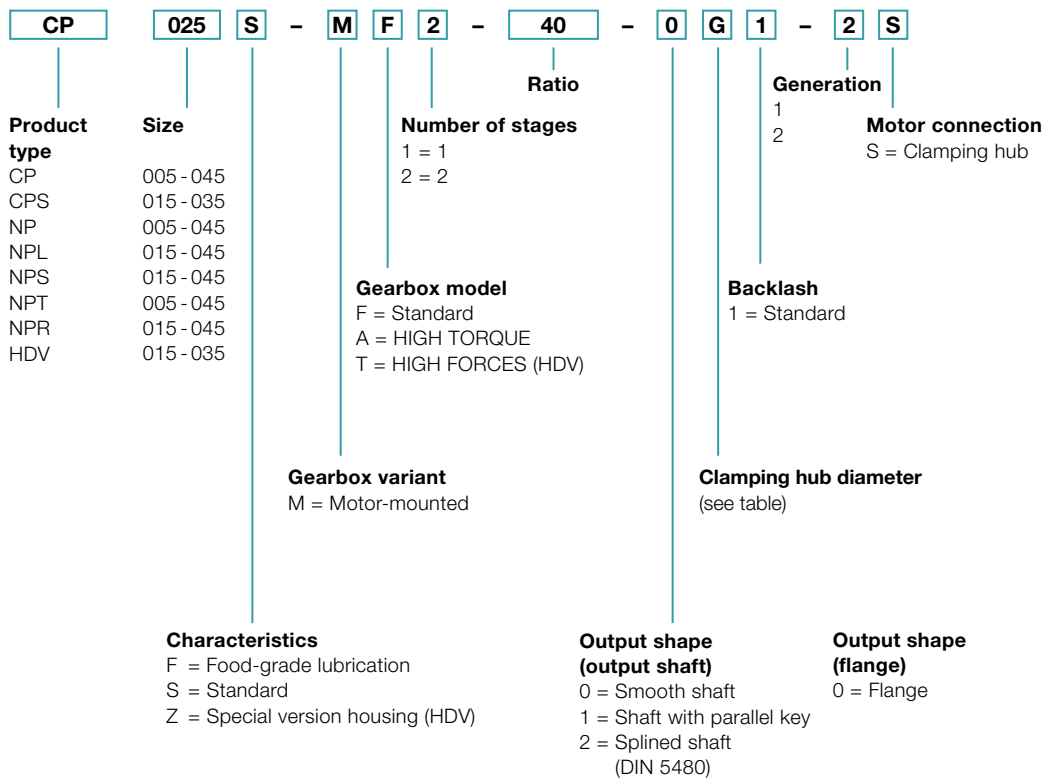

Mounting positions and clamping hub diameters

Clamping hub diameter
 (see technical data sheet for possible diameters)

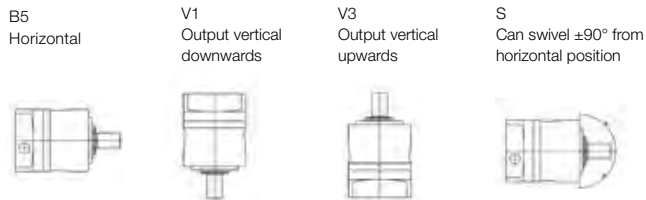

Code letter	mm	Code letter	mm
Z	8	E	19
A	9	G	24
B	11	H	28
C	14	I	32
D	16	K	38

For information purposes only – not required when placing orders!
 Please contact WITTENSTEIN alpha for deviating mounting positions.

Ordering code – bevel gearboxes

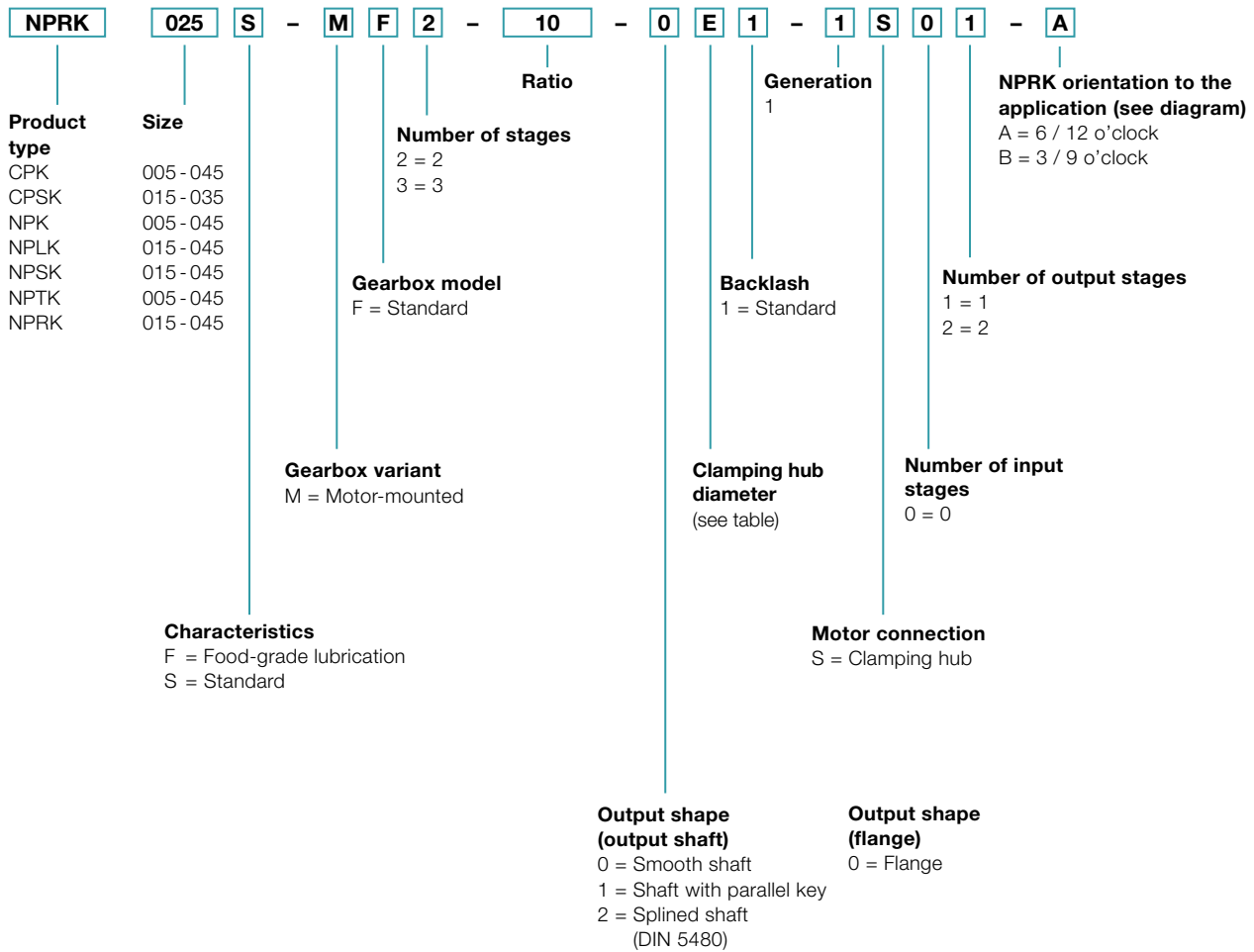

Mounting positions and clamping hub diameters

B5 / V3
 Output horizontal /
 motor shaft vertical upwards

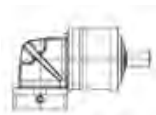

B5 / V1
 Output horizontal /
 motor shaft vertical downwards

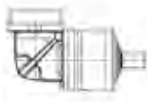

V1 / B5
 Output vertical downwards /
 motor shaft horizontal



V3 / B5
 Output vertical upwards /
 motor shaft horizontal



B5 / B5
 Output horizontal /
 motor shaft horizontal

Clamping hub diameter
 (see technical data sheet for possible diameters)

Code letter	mm
B	11
C	14
E	19
H	28
K	38

Orientation to the application

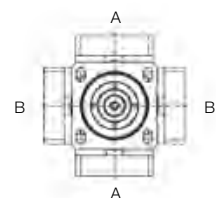

For information purposes only – not required when placing orders!
 Please contact WITTENSTEIN alpha for deviating mounting positions.

Ordering code – worm gearboxes

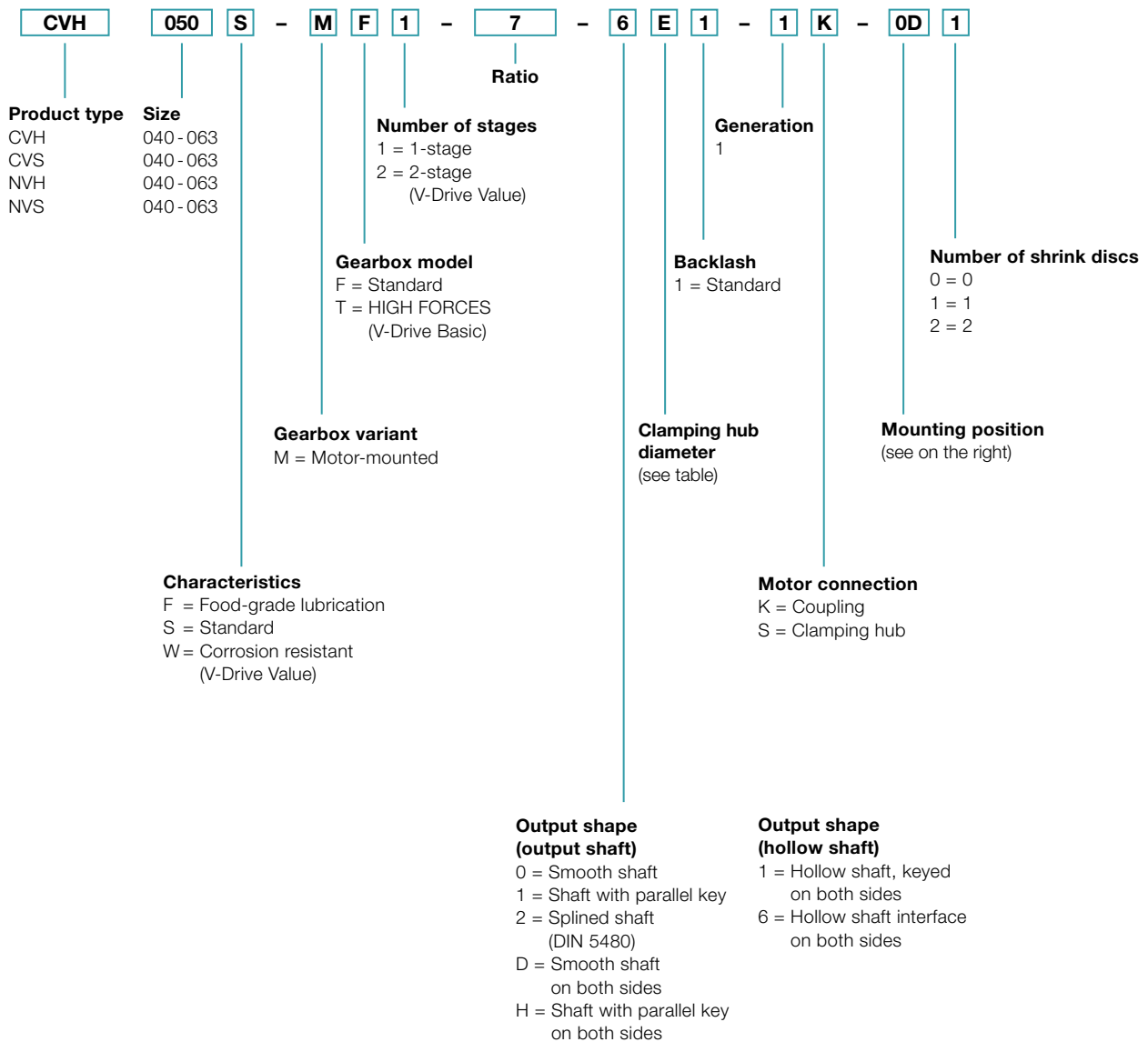

Mounting positions and clamping hub diameters

Mounting position (only relevant for oil volume)

Output side A:
View of the motor connection,
output left
Only valid for CVS, NVS.

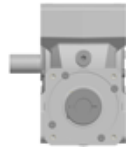

AC



AF



AD



AG



AE



Output side B:
View of the motor connection,
output right
Only valid for CVS, NVS.

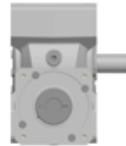

BC



BF



BD



BG



BE



With output shaft or hollow shaft on both sides, A or B in the mounting position is replaced by a 0 (zero).

Clamping hub diameter

(see technical data sheet for possible diameters)

Code letter	mm
C	14
E	19
G	24
H	28

Intermediate sizes possible using bushings
with a minimum wall thickness of 1 mm.



alpha

WITTENSTEIN Inc. · 1249 Humbracht Circle · Bartlett, IL 60103 · USA · Phone 1-630-540-5300

Subject to technical changes. alpha Basic Line & alpha Value Line

WITTENSTEIN alpha – **Intelligent** drive systems

www.wittenstein-us.com

The entire world of drive technology – Catalogs available on request or online at www.wittenstein-us.com/catalogs



alpha Advanced Line. Maximum power density and outstanding positioning accuracy for complex applications.



alpha Basic Line & alpha Value Line. Reliable, flexible and economical solutions for a wide range of applications.



alpha Linear Systems. Precise, dynamic system solutions for every requirement.



alpha Mechatronic Systems. Energy-efficient, versatile and flexible mechatronic drive systems.