

Electrak[®] Throttle Actuator

The Next Generation of Throttle Control Technology

Introducing the Thomson Electrak® Throttle Actuator

Transforming throttle control through innovative design

Thomson has taken the rugged, dependable features of the E050 Electrak® actuator and added capabilities making the throttle actuator an ideal solution for industrial vehicles where throttle control is required. It offers:

- Trusted performance
- Simplified installation
- Space-saving design
- Reduced environmental impact
- Minimal maintenance

Simplify installation and increase operator safety and productivity with the space-saving design and electromechanical interface, allowing engine speed controls to be placed in ergonomic positions.

Reduce the environmental impact of a vehicle by utilizing on-board electronic options such as the analog position feedback sensor, electronic limit switches, and CANBUS communication (SAE J1939), to automatically control engine RPM based upon engine demand to increase productivity while reducing fuel consumption, noise and emissions.

The rugged aluminum housing offers IP69K/IP67 sealing and is e-coated for corrosion resistance to make the throttle actuator virtually maintenance-free.

Need something extra? The Electrak® Throttle actuator can be tailored to your specific application requirements and Thomson engineers are always available to help select an actuator for your application needs.



The Electrak® Throttle Actuator at a Glance

The new Electrak® Throttle Actuator was developed to be the most robust, reliable, and versatile actuator for throttle control applications. Enjoy a simpler and more efficient vehicle design process with the following product innovations:

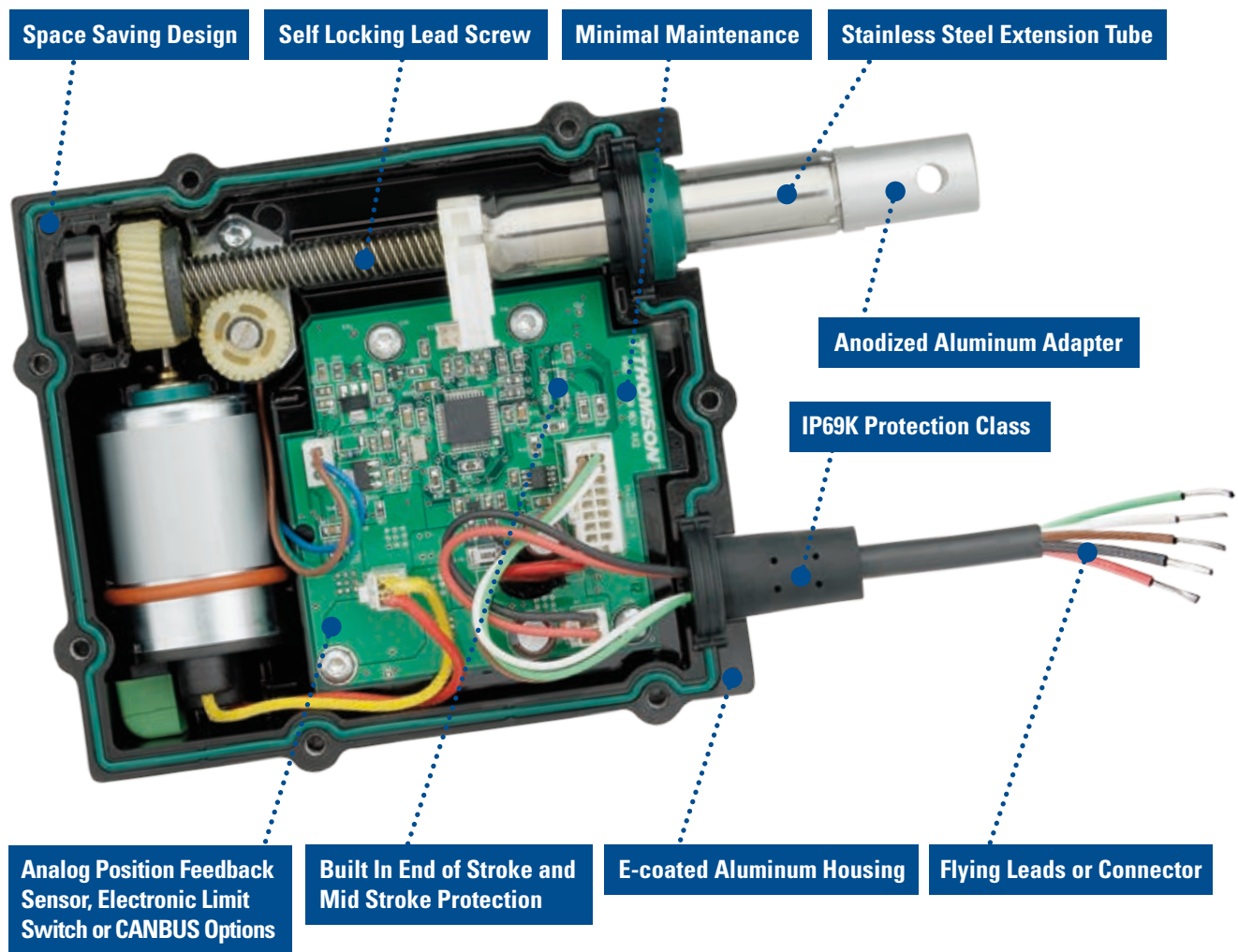

Applications

- Agricultural vehicles
- Marine applications
- Street sweepers
- Auxiliary engines
- Mobile generators
- Construction equipment
- Military and rescue vehicles
- Trucks
- Fork lifts
- Pump trucks
- Garden and forestry equipment
- Mass transport vehicles
- Mining equipment
- Industrial automation

Specifications

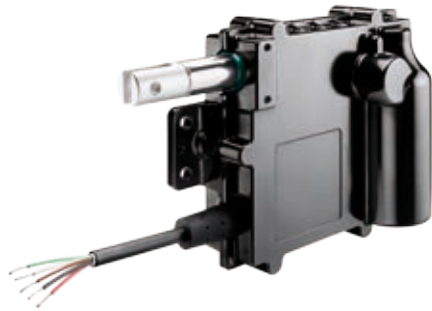

Standard Features and Benefits

- Designed for industrial applications
- Rugged aluminum housing with IP69K/IP67 sealing
- E-coated housing for corrosion resistance
- Minimal maintenance
- Integrated electronic options
- High end features at a low cost
- Integrated mounting holes

General Specifications

Parameter	Electrak Throttle
Screw type	worm
Internally restrained	yes
Manual override	no
Dynamic braking with option CN with option NP, FN, FP	yes no
Holding brake	no (self-locking)
End of stroke protection	yes
Mid stroke protection	yes
Motor protection with temperature rating S with temperature rating E	auto reset thermal switch no
Motor connection	flying leads or Deutsch connector
Certificates	CE, RoHS
Options	<ul style="list-style-type: none"> • extended temperature range • adapter orientation • right angle cable exit • analog position feedback sensor • internal end of stroke limit switches • CANBUS SAE J1939

Performance Specifications

Parameter	Electrak Throttle
Maximum load, dynamic / static ET●●-084 ET●●-174	[N (lbf)] 45 (10) / 90 (20) 130 (30) / 260 (60)
Speed, no load / at max. load ET●●-084 ET●●-174	[mm/s (in/s)] 96 (3.7) / 83 (3.3) 48 (1.9) / 37 (1.45)
Available input voltages	[VDC] 12, 24
Current draw, max. ⁽¹⁾ 12 VDC models 24 VDC models	[A] 4 2
Operating temperature, min	[°C (F)] - 40 (-40)
Operating temperature, max ET●●●●●●S ET●●●●●●E	[°C (F)] 85 (185) 125 (257)
Full load duty cycle @ 25 °C ⁽²⁾	[%] 50
End play, maximum	[mm (in)] 1.5 (0.06)
Restraining torque	[Nm (lbf-in)] 0
Motor cable lead cross section	[mm ² (AWG)] 0.8 (18)
Motor cable length	[mm (in)] 165 (6.5)
Protection class	IP69K, IP67
Operational life	[cycles] 500000
Retracted length	[mm (in)] 184.7 (7.27)
Stroke length	[mm (in)] 50.8 (2)
Weight	[kg (lbs)] 1.11 (2.5)
Analog feedback sensor linearity	[± %] 1

⁽¹⁾ Max. current draw ratings do not include motor inrush current. Typical inrush current values are 12 A at 12 VDC and 6 A at 24 VDC.

⁽²⁾ For all models and load ranges.

Dimensions and Performance Diagrams

Dimensions	Projection
METRIC [INCH]	

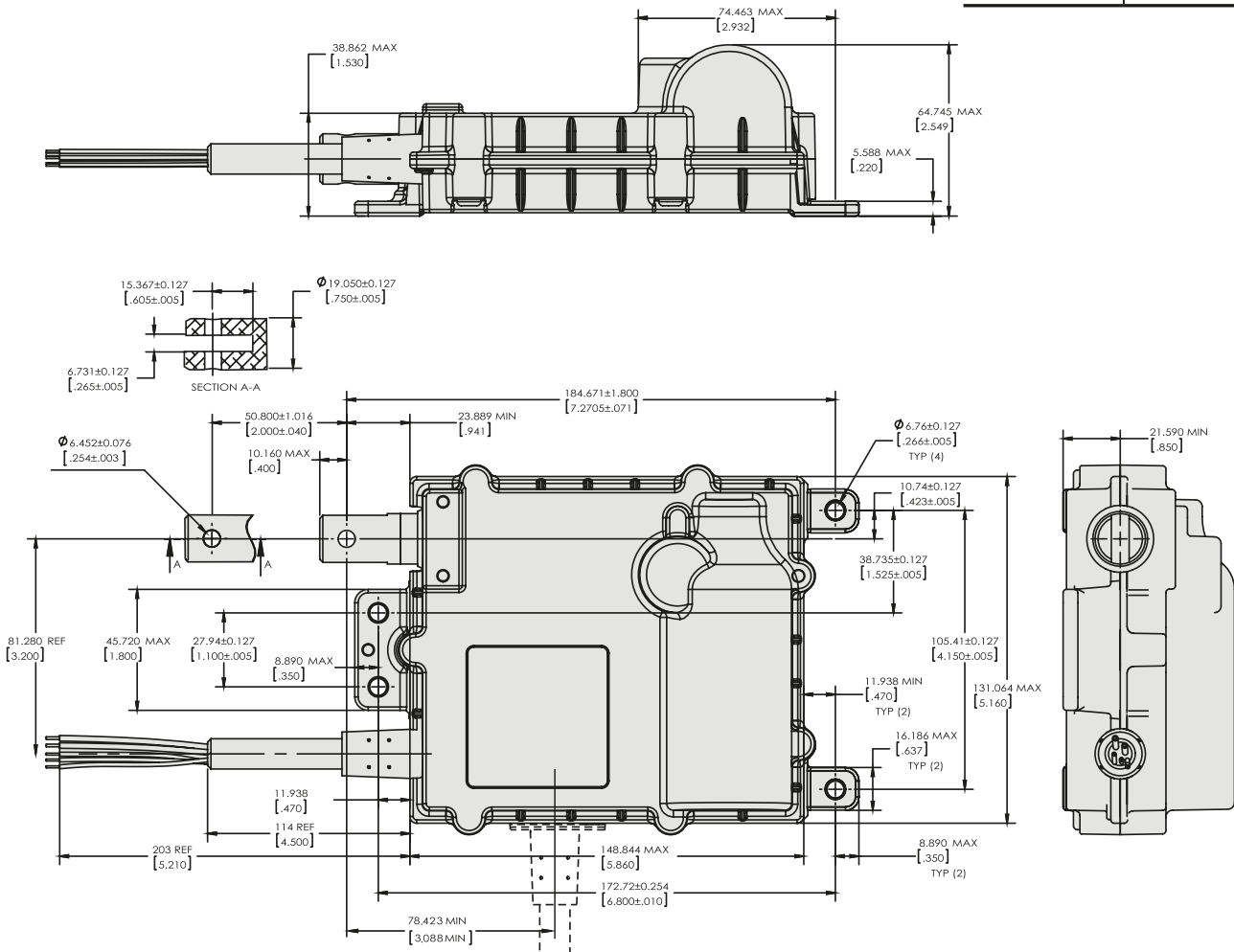

Performance Diagrams

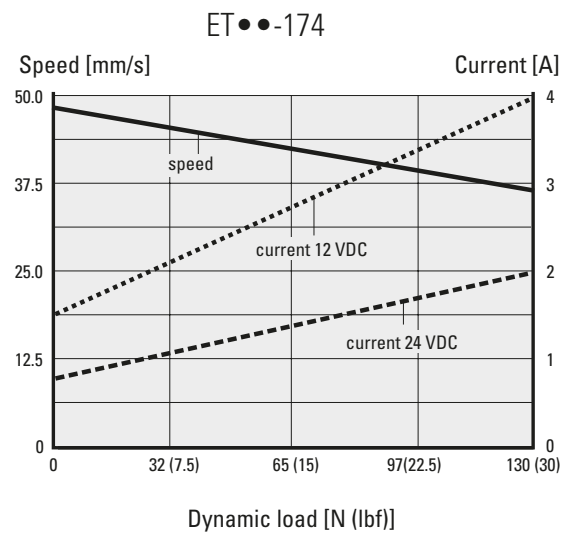
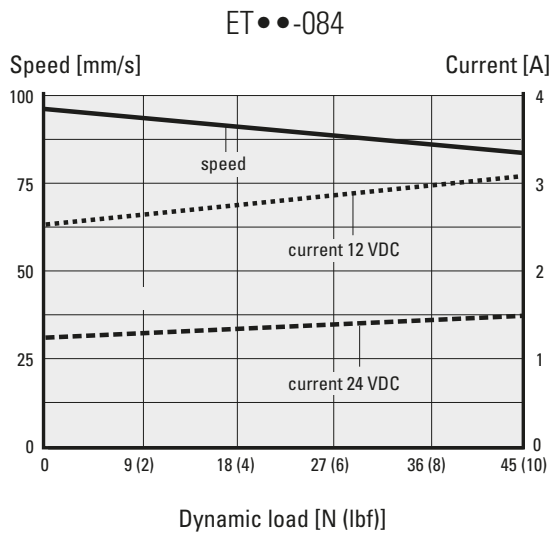

Electrical Installation

Cable and Connector Installation

Connect the actuator according to the table below. Actuator will extend if connected as in the table, shift polarity between red (pin 1) and black (pin 3) leads and it will retract. Mating Deutsch connector kit can be ordered from Thomson (P/N 9100-448-021). Note: Connector pin 2 is not used, but contains a sealing plug.

Option name and order key code	Lead color or Deutsch DTM04-6P connector pin number				
	Red (1)	Black (3)	Brown (4)	White (5)	Green (6)
Analog position feedback sensor (NP)	Motor (+)	Motor (-)	VDC in (+)	VDC out	VDC in (-)
End of stroke limit switches (FN)	Motor (+)	Motor (-)	-	-	-
Analog position feedback sensor and limit switches (FP)	Motor (+)	Motor (-)	VDC in (+)	VDC out	VDC in (-)
CANBUS SAE J1939 (CN)	Power (+)	Power (-)	CAN High	CAN Shield*	CAN Low

* Not required to connect.

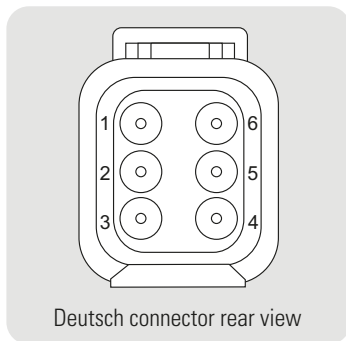

Analog Position Feedback Sensor Installation Data

Brown (pin 3) and green (pin 6) are connected to a voltage source. When extending the actuator the voltage will increase between green (pin 6) and white (pin 5).

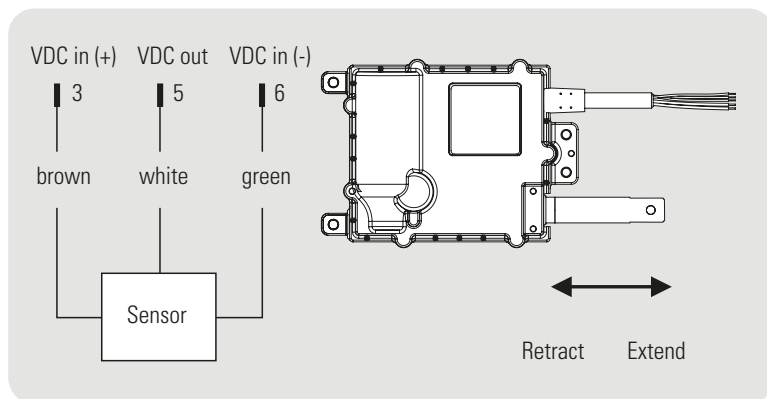

Sensor Specifications

Input voltage, max. (VDC in) [VDC]	32
Output voltage (VDC out) at fully retracted at fully extended [VDC]	< 5 % VDC in > 75% VDC in
Max. output current [mA]	1
Linearity [± %]	1

Ordering Key

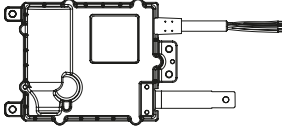
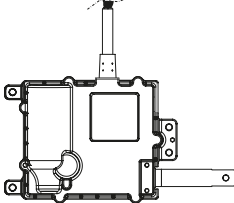
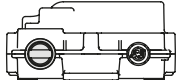
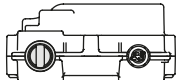
Ordering Key							
Position	1	2	3	4	5	6	7
Example	ET12-	174-	S	S	NP	1	S
<p>1. Actuator type and supply voltage ET12- = Electrak® Throttle, 12 VDC ET24- = Electrak® Throttle, 24 VDC</p> <p>2. Max. dynamic load and speed version 084- = 45 N (10 lbf), high speed 174- = 130 N (30 lbf), standard speed</p> <p>3. Harness orientation S = parallel to adapter R = rotated 90° in housing</p> <p>S </p> <p>R </p>			<p>4. Temperature rating S = standard: -40 (-40) to +85 (+185) °C (F) E = high temperature: -40 (-40) to +125 (+257) °C (F) *</p> <p>5. Control option NP = analog position feedback sensor FN = end of stroke limit switches FP = analog position feedback sensor and end of stroke limit switches CN = CANBUS SAE J1939</p>			<p>6. Connection options 1 = flying leads 2 = Deutsch DTM04-6P connector</p> <p>7. Adapter options S = standard adapter orientation M = adapter rotated 90°</p> <p>S </p> <p>M </p>	

* Note that there is no thermal switch to protect the motor on the high temperature rated models.

EUROPE

United Kingdom

Thomson
Office 9, The Barns
Caddsdow Business Park
Bideford
Devon, EX39 3BT
Phone: +44 (0) 1271 334 500
E-mail: sales.uk@thomsonlinear.com

Germany

Thomson
Nürtinger Straße 70
72649 Wolfschlügen
Phone: +49 (0) 7022 504 0
Fax: +49 (0) 7022 504 405
E-mail: sales.germany@thomsonlinear.com

France

Thomson
Phone: +33 (0) 243 50 03 30
Fax: +33 (0) 243 50 03 39
E-mail: sales.france@thomsonlinear.com

Italy

Thomson
Largo Brughetti
20030 Bovisio Masciago
Phone: +39 0362 594260
Fax: +39 0362 594263
E-mail: sales.italy@thomsonlinear.com

Spain

Thomson
E-mail: sales.esm@thomsonlinear.com

Sweden

Thomson
Estridsväg 10
29109 Kristianstad
Phone: +46 (0) 44 24 67 00
Fax: +46 (0) 44 24 40 85
E-mail: sales.scandinavia@thomsonlinear.com

SOUTH AMERICA

Brasil

Thomson
Av. Tamboré, 1077
Barueri, SP – 06460-000
Phone: +55 (11) 3616-0191
Fax: +55 (11) 3611-1982
E-mail: sales.brasil@thomsonlinear.com

USA, CANADA and MEXICO

Thomson
203A West Rock Road
Radford, VA 24141, USA
Phone: 1-540-633-3549
Fax: 1-540-633-0294
E-mail: thomson@thomsonlinear.com
Literature: literature.thomsonlinear.com

ASIA

Asia Pacific

Thomson
E-mail: sales.apac@thomsonlinear.com

China

Thomson
Rm 2205, Scitech Tower
22 Jianguomen Wai Street
Beijing 100004
Phone: +86 400 6661 802
Fax: +86 10 6515 0263
E-mail: sales.china@thomsonlinear.com

India

Thomson
c/o Fluke Technologies Pvt. Ltd.
#424, Deodhar Center,
Marol Maroshi Road,
Andheri – E, Mumbai – 400059 India
Phone: +91 22 29207641
E-mail: sales.india@thomsonlinear.com

Japan

Thomson
Minami-Kaneden 2-12-23, Suita
Osaka 564-0044 Japan
Phone: +81-6-6386-8001
Fax: +81-6-6386-5022
E-mail: csjapan@scgap.com

Korea

Thomson
F7 Ilsong Bldg, 157-37
Samsung-dong, Kangnam-gu,
Seoul, Korea (135-090)
Phone: +82 2 6917 5049
Fax: +82 2 528 1456
E-mail: sales.korea@thomsonlinear.com

www.thomsonlinear.com

Electrak_Throttle_Actuator_BRUK-0006-03B | 20160920 SK
Errors and technical alterations reserved. It is the responsibility of the product user to determine the suitability of this product for a specific application. All trademarks property of their respective owners. © 2016 Thomson Industries, Inc.

 **THOMSON**[®]

Linear Motion. Optimized.[™]