



aerospace
climate control
electromechanical
filtration
fluid & gas handling
hydraulics
pneumatics
process control
sealing & shielding



Parker Automation Controller

Intelligent Multi-Axis Motion Controller



ENGINEERING YOUR SUCCESS.



WARNING – USER RESPONSIBILITY

FAILURE OR IMPROPER SELECTION OR IMPROPER USE OF THE PRODUCTS DESCRIBED HEREIN OR RELATED ITEMS CAN CAUSE DEATH, PERSONAL INJURY AND PROPERTY DAMAGE.

- This document and other information from Parker-Hannifin Corporation, its subsidiaries and authorized distributors provide product or system options for further investigation by users having technical expertise.
- The user, through its own analysis and testing, is solely responsible for making the final selection of the system and components and assuring that all performance, endurance, maintenance, safety and warning requirements of the application are met. The user must analyze all aspects of the application, follow applicable industry standards, and follow the information concerning the product in the current product catalog and in any other materials provided from Parker or its subsidiaries or authorized distributors.
- To the extent that Parker or its subsidiaries or authorized distributors provide component or system options based upon data or specifications provided by the user, the user is responsible for determining that such data and specifications are suitable and sufficient for all applications and reasonably foreseeable uses of the components or systems.

Overview	5
Product Overview.....	6
Technical Characteristics.....	8
Technical Data.....	8
Standards and Conformance	8
Dimensions	9
Accessories and Options	10
Communication Modules	10
Parker Automation Controller I/O Modules.....	10
Software - Parker Automation Manager	11
Control Network Architecture	12
Related Products	13
Parker Servo Drive (PSD).....	13
SME: Brushless servo motors	13
Interact Xpress: HMI	13
Handling actuators	13
Order Code.....	14
Parker Automation Controller	14

Parker Hannifin

The global leader in motion and control technologies

A world class player on a local stage

Global Product Design

Parker Hannifin has more than 40 years experience in the design and manufacturing of drives, controls, motors and mechanical products. With dedicated global product development teams, Parker draws on industry-leading technological leadership and experience from engineering teams in Europe, North America and Asia.

Local Application Expertise

Parker has local engineering resources committed to adapting and applying our current products and technologies to best fit our customers' needs.

Manufacturing to Meet Our Customers' Needs

Parker is committed to meeting the increasing service demands that our customers require to succeed in the global industrial market. Parker's manufacturing teams seek continuous improvement through the implementation of lean manufacturing methods throughout the process. We measure ourselves on meeting our customers' expectations of quality and delivery, not just our own. In order to meet these expectations, Parker operates and continues to invest in our manufacturing facilities in Europe, North America and Asia.

Electromechanical Worldwide Manufacturing Locations

Europe

Littlehampton, United Kingdom
Dijon, France
Offenburg, Germany
Filderstadt, Germany
Milan, Italy

Asia

Wuxi, China
Jangan, Korea
Chennai, India

North America

Rohnert Park, California
Irwin, Pennsylvania
Charlotte, North Carolina
New Ulm, Minnesota



Offenburg, Germany

Local Manufacturing and Support in Europe

Parker provides sales assistance and local technical support through a network of dedicated sales teams and authorized technical distributors throughout Europe.

For contact information, please refer to the Sales Offices on the back cover of this document or visit www.parker.com



Milan, Italy



Littlehampton, UK

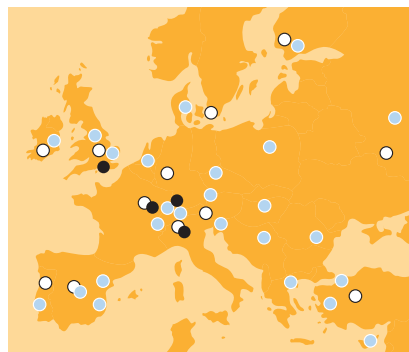

- Electromechanical Manufacturing
- Parker Sales Offices
- Distributors



Dijon, France

Parker Automation Controller - PAC

Overview

Description

Powerful, integrated, and designed for the global machine market, the EtherCAT based Parker Automation Controller (PAC) combines machine logic, real-time motion control and visualization into a standard based, performance driven, fan-less and easily mountable din rail solution. This programmable automation controller comes equipped with a native, real-time EtherCAT bus for high-speed I/O and motion control, a modular interface slot for 3rd Party device communication, standard Ethernet and USB ports plus onboard SD program storage. Programmed with the Parker Automation Manager software, OEMs can produce efficient, high-performance control systems based on the IEC61131-3 and PLCopen Motion standards.

The motion controller's solid state design is precisely engineered for demanding industrial environments. The powerful, yet energy efficient Intel® Atom™ N2600 processor allows for fanless operation while supporting dual-cores, 64-bit instructions, and Hyper-threading technology. Coupled with the removable, solid state SD storage media, all moving parts have been eliminated for a robust, industrial grade control solution.

Features

- IEC61131-3 programming
- PLCopen motion control
- Simulation runtime
- High-speed EtherCAT
- Dual Ethernet networks
- Local and remote I/O
- SD application memory
- Modular communication interface
- Intel® N2600 dual core, 1.60 GHz, 64bit
- 1 GB DDR3 SDRAM
- Fan-less operation
- CNC capability
- DIN rail mounted
- Web configuration tool



Technical Characteristics - Overview

Parker Automation Controller - PAC	
Supply voltage	24 VDC -15 %/+25 %
CPU	Intel® N2600 CPU, 1.6 GHz, Dual Core, 64bit 1 MB L2 Cache
Memory	Up to 1 GB SDRAM
Storage	2 GB
Ports	2x RJ-45 10/100/1000BaseT Ethernet 1x RJ45 100Mbit/s EtherCAT supporting IEEE1588 distributed clocks 2x USB 2.0 Host Type A
Storage temperature	-25...+70 °C
Operating temperature	0...+50 °C
Relative humidity	5...95 %, non-condensing
Built-in fieldbus	EtherCAT 100 Mbit/s
Dimensions	25x120x90 mm (WxHxD)
Shielding	Connected straight to module housing
Installation	35 mm DIN rail (top-hat rail)
Protection	IP20
CE Compliant	2004/108/EC Electromagnetic Compatibility
UL	UL508 & UL61010-1 / UL61010-2-201

Product Overview Parker Automation Controller

Designed for OEMs to maximize efficiency while exceeding performance expectations, the Parker Automation Control System comprises the Parker Automation Controller (PAC), the Parker Automation Manager Integrated Development Environment (IDE), and the PAC I/O System. Together these elements provide OEMs with a powerful, standards-based programmable automation controller designed to tackle the most demanding applications. The PAC System consolidates machine logic, signal handling, advanced motion, and visualization into one performance driven solution, thus eliminating unnecessary hardware and communication links, and maximizing developer efficiency.

I/O Modules



The PAC I/O System comprises a variety of modules for digital, analog, temperature signals, high-speed counters and communication interfaces.



SD storage

- SD card allows applications and data to be stored

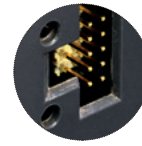

PAC side

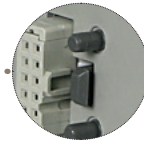

I/O side

E-Bus connector

- Provides fast EtherCAT connectivity for local PACIO Modules
- Vibration proofed connection



Push button

- IP address log button and clearing of the "ERROR" LED.



Intel® N2600 Dual Core Processor

- 1GB DDR3 SDRAM
- 64 bit instructions
- Fan-less Operation

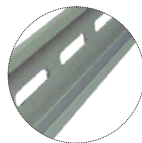

DIN rail mount

- Easy installation



Power connector

- Connector for input power, +24VDC nominal.

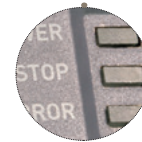

System status LEDs

- 3 LEDs indicate the system status



USB ports

- Dual standard USB 2.0 ports, type A

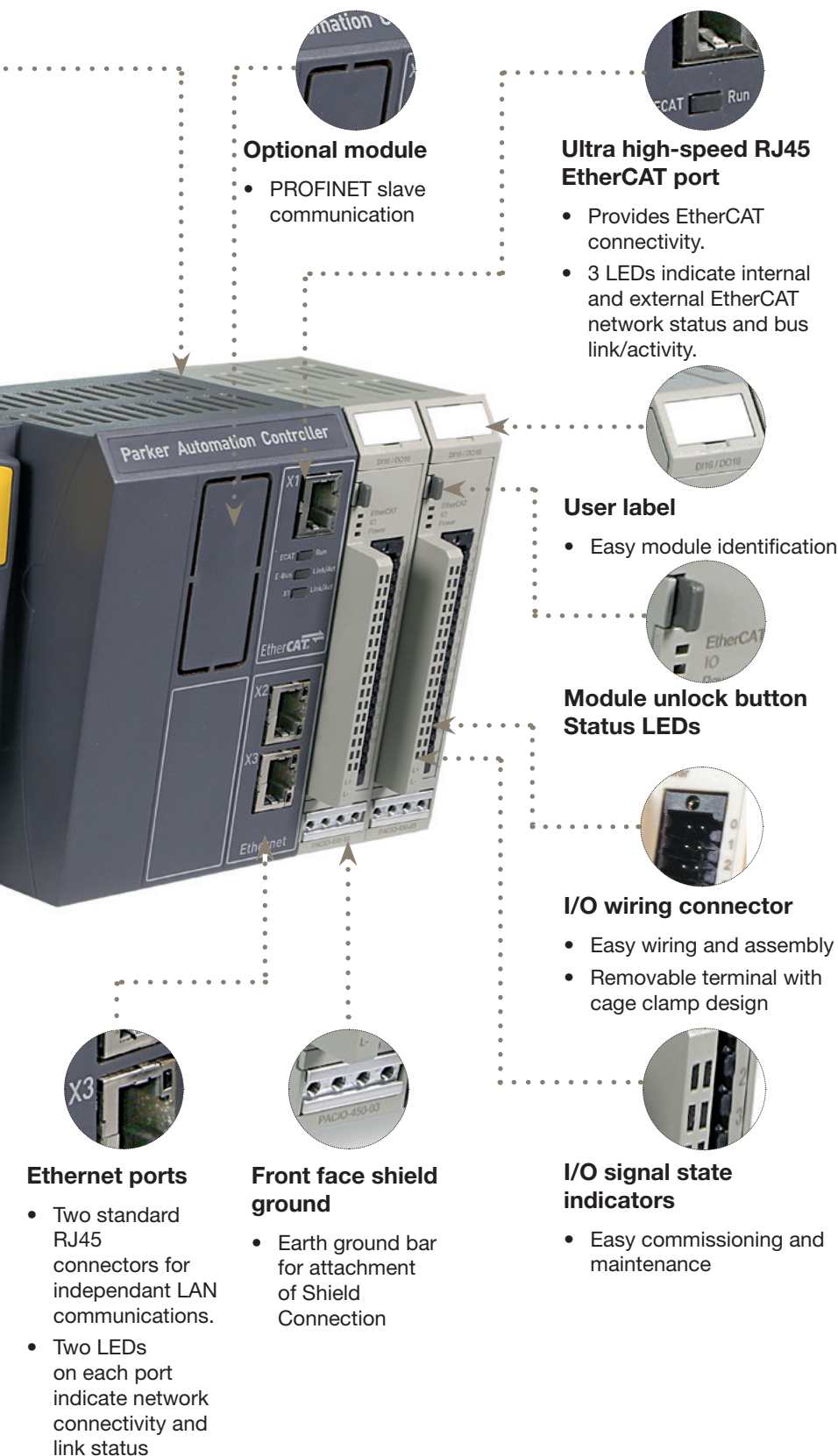

Software - Parker Automation Manager

Designed specifically to meet the needs of OEMs, the Parker Automation Manager (PAM) provides tools for faster code generation, modular code reuse and decreased commissioning times and thus supports faster times to market, decreases development cost, and increases ROI.



Engineers can work smarter, more efficiently and more effectively by choosing from the five IEC standard programming languages to optimize for an application, by using industry standard PLCopen Motion for motion control programming, deploying to the powerful simulation runtime for faster development and using online variable watch and trending for logic analysis.

Parker Automation Manager puts the engineer first and provides all the tools to make control programming smart and efficient.

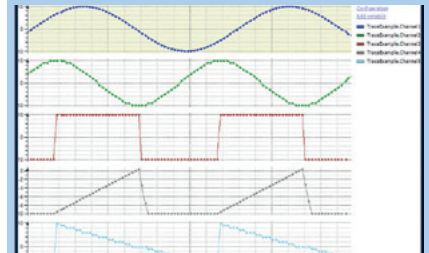

- IEC61131-3 programming
- PLCopen motion control
- Simulation runtime
- Web configuration tool
- Advanced Cam Editor
- CNC capability
- PLCopen motion control I, II, III

Technical Characteristics

Technical Data

Input voltage	24 VDC (-15 %/+25 %), SELV limited energy, 1.2 A, 29 W Power must be provided by a class 2 power source. Overvoltage category 1
CPU	Intel® N2600 CPU, 1.6 GHz, Dual Core, 64bit, 1 MB L2 Cache
Memory	Up to 1 GB DDR3 SDRAM (minimum), 1066 MHz, PC3-8500, 204-pin SODIMM Socket
Storage	2 GB (minimum) Secure Digital Card (SD)
Fuse	Littelfuse Nano SMF slow blow type; part number R454002
Heat dissipation	Without optional communications module: 5.0 W maximum With optional communications module: 5.8 W maximum
Maximum number of PACIO modules	Up to 20 modules connected to the controller or, maximum 5 VDC @3 A E-bus load. More than 20 modules can be added to the PAC320 by using the extender module and bus coupler module. See the PACIO bus coupler section of the user guide
Electrical insulation	Modules electrically insulated from one another and from the bus
IO connection	Spring-assisted combi plug with mechanical ejector, 4...36 pin
Diagnosis indication	LED located next to the terminal LED: bus state, module state, broken wire/excessive current
Number of ports	Up to 32 digital I/Os on every module, up to 8 analog channels per module
Noise immunity	Zone B to EN 61131-2, installation on an earthed top at DIN rail in the earthed control cabinet
Shock rating	10 g peak; 11 ms (operating) 30 g peak; 11 ms (non-operating)
Operating vibration	10...500 Hz: 2 grms random
Altitude	3048 m (10000 Feet)

Standards and Conformance

Tests	Specification
Harmonic current emissions	EN 61000-3-2:2006 + A2:2009 IEC 61000-3-2:2009
Voltage fluctuations and flicker	EN 61000-3-3:2008 IEC 61000-3-3:2008
Electrostatic discharge immunity	IEC 61000-4-2:2008
Radiated electromagnetic field immunity	IEC 61000-4-3:2010
Electrical fast transient burst immunity	IEC 61000-4-4:2012
Surge immunity	IEC 61000-4-5:2005
Radio frequency common mode immunity	IEC 61000-4-6:2008
Power frequency magnetic field immunity	IEC 61000-4-8:2009
Voltage interrupts immunity	IEC 61000-4-11:2004
Radiated & conducted emissions	EN 55011:2009 + A1:2010
CISPR 11 Group 1, Class A	CISPR 11:2009 + A1:2010
EN61010-1:2010	Safety Requirements for Electrical Equipment for Measurement, Control and Laboratory use. Part 1 General Requirements
EN61010-2-201:2013	Safety Requirements for Electrical Equipment for Measurement, Control and Laboratory use. Part 2-201 Particular Requirements for Control Equipment
UL 61010-1, 3rd Edition, 2012-04-17 UL File E243373	Electrical Equipment for Measurement, Control and Laboratory use. Part 1: General Requirements
CAN/CSA-C22.2 No. 61010-1, 3rd Edition, 2012-04	Electrical Equipment for Measurement, Control and Laboratory use. Part 1: General Requirements
UL 61010-2-201	Safety requirements for electrical equipment for measurement, control, and laboratory use, Part 2-201: Particular requirements for control equipment
IEC 60529, Edition 2.1 + Corr. 1:2003 + Corr. 2:2007 + Corr. 3:2009	Protection Degree IP20

Dimensions

Parker Automation Controller Dimensions

Dimensions [mm]

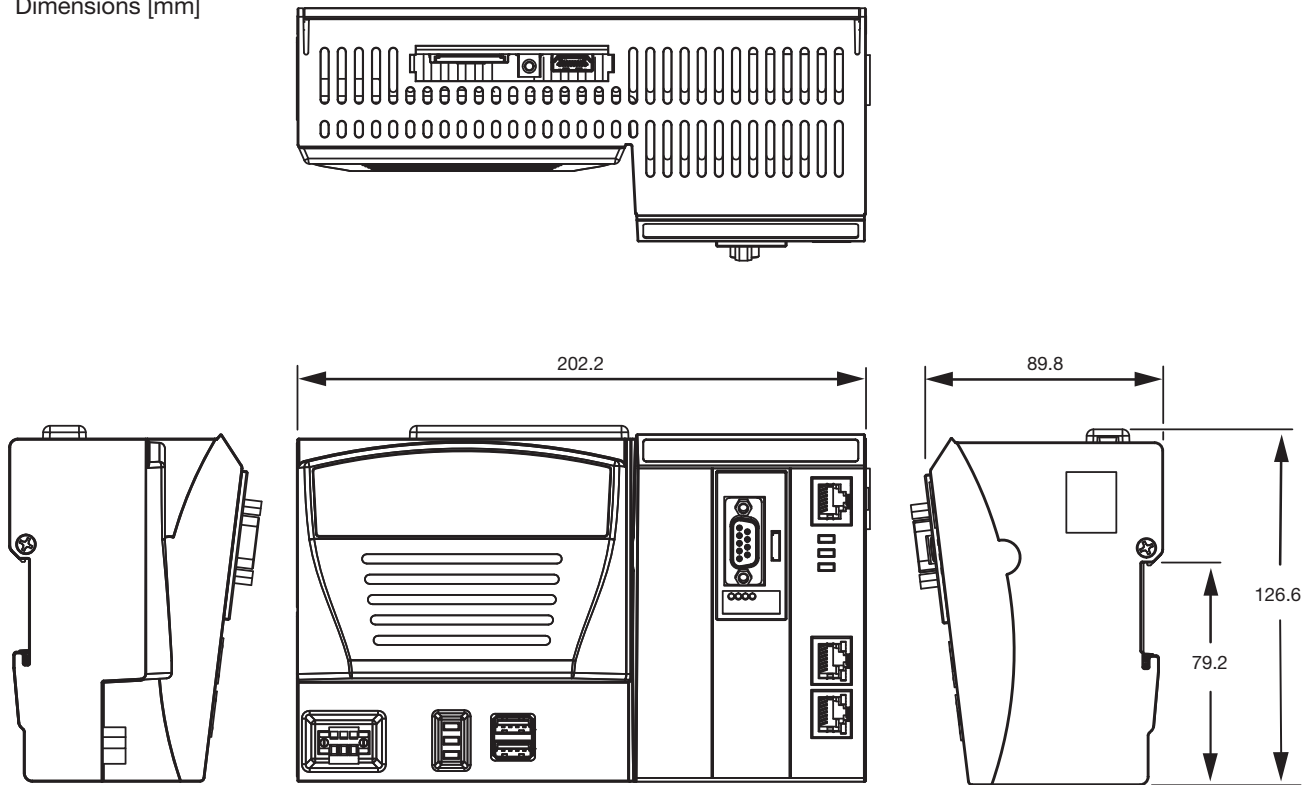

I/O Dimensions

Dimensions [mm]

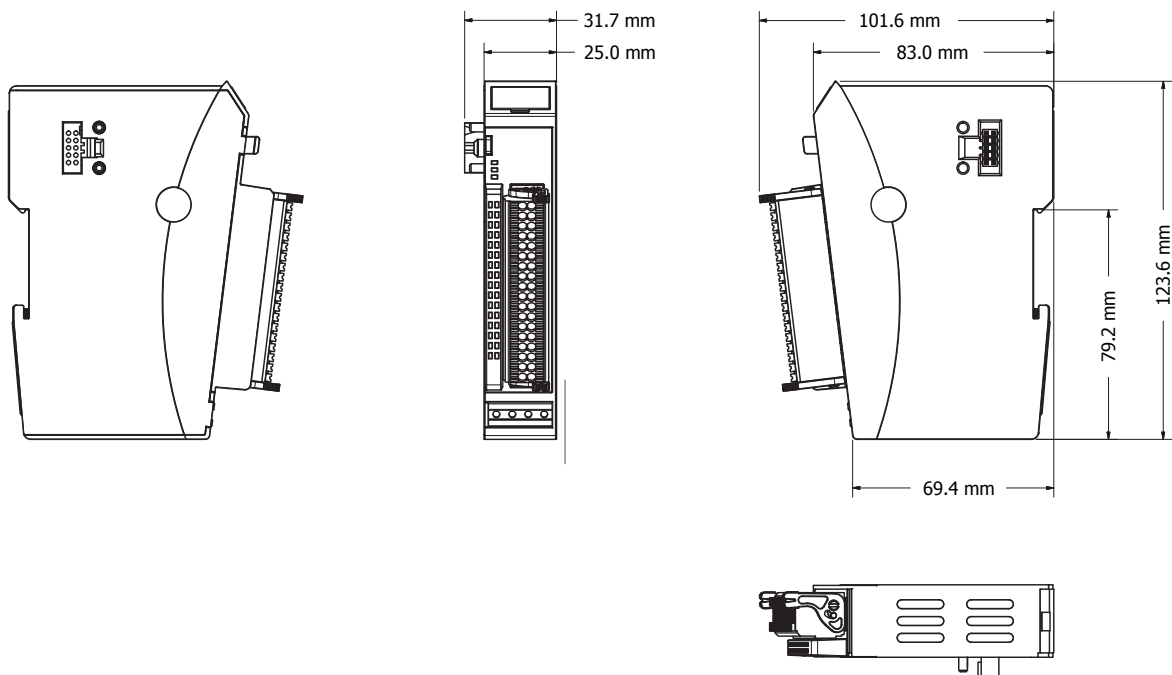

Accessories and Options

Communication Modules

The Parker Automation Controller (PAC) comes standard with the industry leading high-speed EtherCAT communication bus for motion, I/O, and 3rd party device connectivity.

Coupled with the standard modular communication interface, dual LAN capability, and ability to integrate directly into Ethernet/IP networks (Modbus TCP is also available), the PAC provides unprecedented connectivity for complimentary devices and network isolation for IT professionals.



PROFINET communication module

The following communication protocols are available:

- EtherCAT
- PROFINET
- Profibus (via PACIO slave module)
- Ethernet/IP
- Modbus TCP (Master & Slave as a standard on every unit)

Parker Automation Controller I/O Modules

The PAC I/O System comprises a variety of modules for digital, analog and temperature signals as well as communication interfaces. The modules connect directly to the controller via the built-in EtherCAT bus for local architectures and are extended to remote locations via the extender and bus coupler modules, thus supporting both local and distributed I/O architectures.

PAC I/O modules feature a removable cage-clamp terminal design which provides for easy wiring and assembly and allows for the removal and insertion of modules without interfering with wiring; LED status indicators for the EtherCAT bus, I/O, power and each signal channel; front-face shield-grounding to the din-rail; removable label inserts; easy access front mounted module disconnects; and laser etched identification and schematic information. PAC I/O communicates natively on the EtherCAT bus and is unencumbered by protocol converters; therefore it provides the full functionality and throughput of high-speed EtherCAT to meet the most demanding I/O requirements.



Module Type	Part Number	PACIO Description
Bus Coupler	PACIO-400-00	PACIO EtherCAT Bus coupler, 3 A
Digital I/O Modules	PACIO-450-02	PACIO DI16/DO8 (16 inputs/8 outputs), 1 A
	PACIO-450-03	PACIO DI16/DO16 (16 inputs/16 outputs), 1 ms delay, 0.5 A
	PACIO-450-13	PACIO DI16/DO16 (16 inputs/16 outputs), 1 ms delay, 0.5 A Low-side
	PACIO-451-02	PACIO DI32 (32 inputs), 1 ms delay
	PACIO-451-03	PACIO DI16 (16 inputs), 1 ms delay
	PACIO-450-05	PACIO DI8/DO8 (8 inputs/8 outputs), 1 ms delay, 0.5 A
	PACIO-452-01	PACIO DO16 (16 outputs), 0.5 A
	PACIO-452-02	PACIO DO8 (8 outputs)1 A
	Analog	PACIO-441-01
PACIO-441-02		PACIO AI4/8-VDC (4 differential/8 single-ended analog input module), 13 Bit
PACIO-442-02		PACIO AO4-VDC/mA (4 analog output module), 12 Bit resolution
Temperature	PACIO-443-01	PACIO AI4-Pt/Ni100 (4 analog inputs, 70 to 300 ohm resistance), 16 Bit
	PACIO-443-03	PACIO AI4-Pt/Ni1000 (4 analog inputs, 70 to 3000 ohm resistance), 16 Bit
Counter	PACIO-454-01	PACIO Counter/Enc (encoder counter module)
Interfaces	PACIO-455-03	PACIO Profibus DP Slave Module
	PACIO-400-02	PACIO Extender 2 Port (EtherCAT I/O extender)
Accessories	PACIO-412-01	PACIO Shield 2x8 mm
	PACIO-412-02	PACIO Shield 14 mm
	PACIO-411-00	Power Distribution Module (distributes 0 VDC or 24 VDC attached at pins L1 or L2)

Software - Parker Automation Manager

Smart and powerful, Parker's Automation Manager is the single, integrated development environment for programming complex machine logic, signal handling, advanced motion, and visualization.

Engineers can now manage an entire product line in one project by simply configuring multiple hardware devices and application containers, deploying reusable software packages to specific application containers and then activating the appropriate application container to download to specific machines. This method allows OEMs to maintain their program files in one project and make code changes in one place to affect all versions of a particular machine. Thus machine builders now have a development platform specifically designed to support modular machines and valuable add-on software modules.

- Customizable Interface
- Powerful cam editor
- Alarm Configuration
- PAC-to-PAC Communication
- Recipe Manager
- Unit Conversion
- Web Visualization
- Retentive Variables

With Automation Manager, engineers can leverage their existing knowledge and work smarter, more efficient and more effective than ever with the full suite of IEC 61131 programming languages and Parts I, II and III of PLCOpen Motion Control. This standards-based approach flattens the learning curve and provides a common platform for control engineers. The standard platform is complimented by Simulation Runtime for simulating logic and motion on the development computer for faster development and by a complete suite of debugging tools, including online variable watch, trending, logging and breakpoints for logic analysis. Automation Manager supports reusable, extensible software with package referencing and object oriented programming techniques, including methods to protect software



implementations and thus the intellectual property of OEMs. In short, Automation Manager is designed specifically for OEMs to decrease development and commissioning time; to support modular, reusable, extensible and protected code; and to provide engineers with the environment and tools necessary to create control applications for the complex, demanding machines of our time.

- IEC61131-3 programming languages
 - Ladder diagram
 - Structured text
 - Function block diagram
 - Sequential function chart
 - Instruction list
- PLCOpen motion control I, II, III



- Simulation Runtime for code & motion
- Variable watch & trending
- Auto-declaration
- Smart coding auto-complete
- Breakpoint debugging
- Custom function/function block development
- CNC development
- DXF file import
- G-code generation

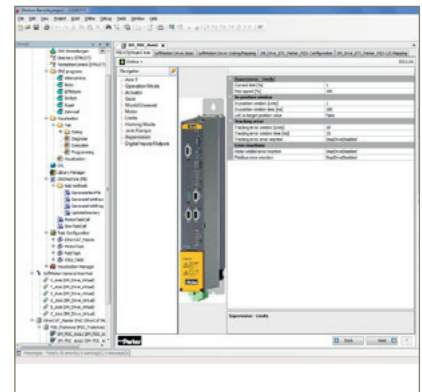

Programming

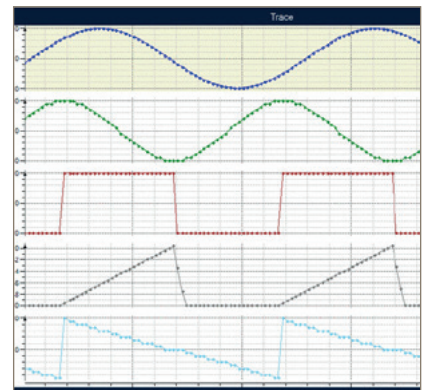

Trace / debugging

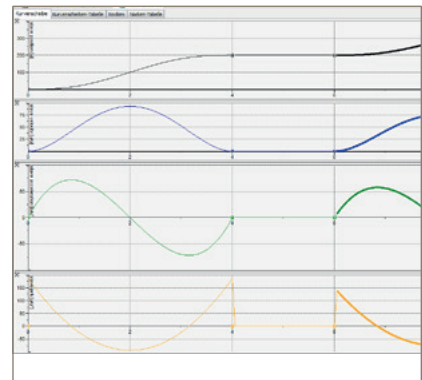

CAM Design

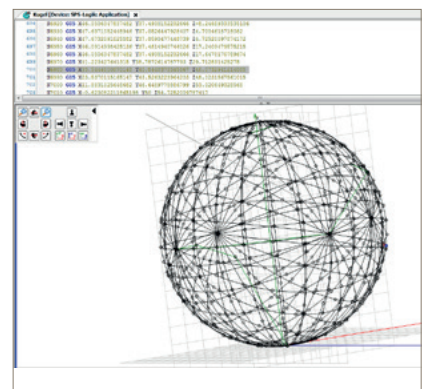

CNC Design

Control Network Architecture

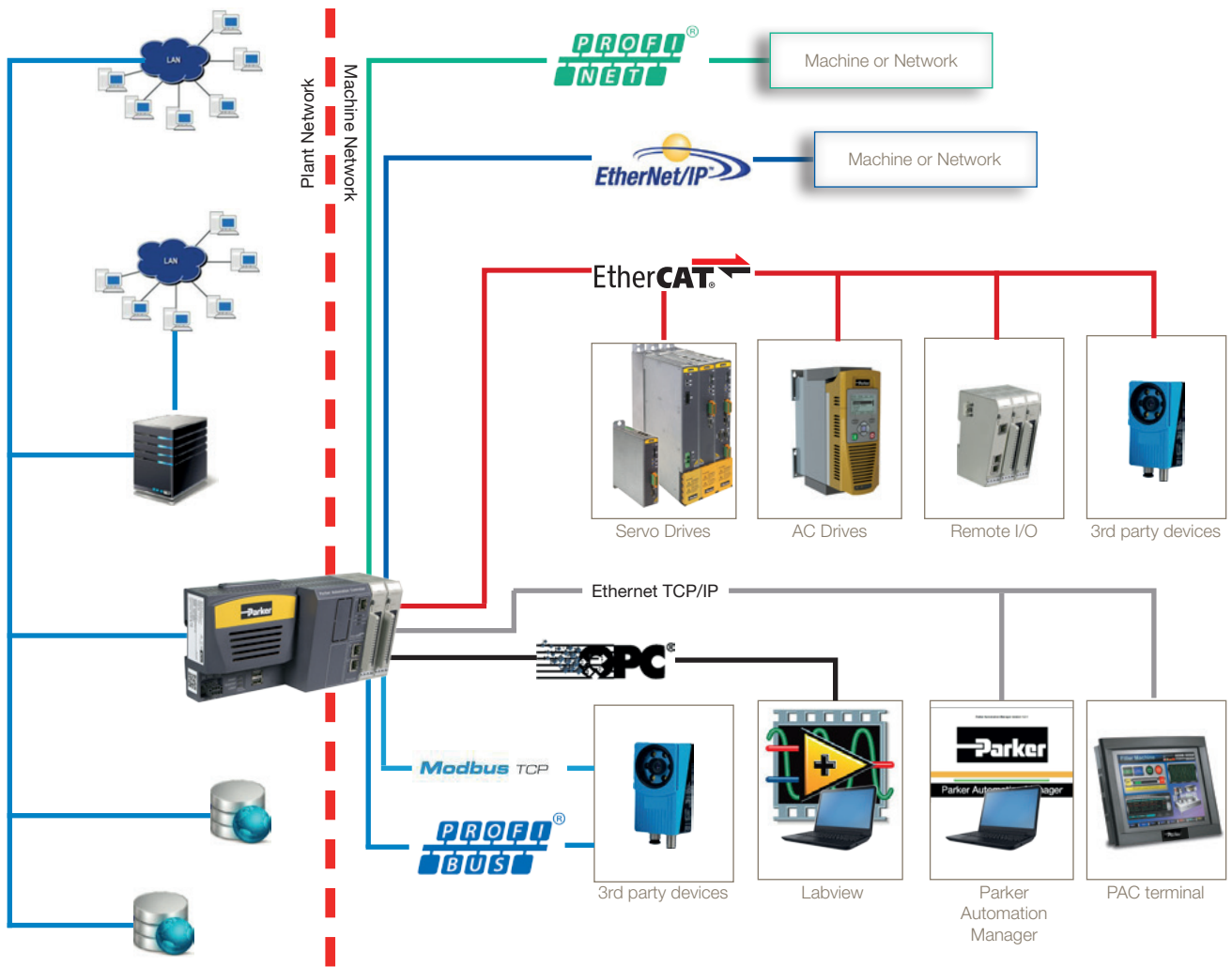

Related Products

Parker Servo Drive (PSD)

The PSD1 is Parker Servo Drive family available with different power rating and form factors. Today the offering contains:

The PSD1-S is the standalone version which can be connected directly to the main supply.

The PSD1-M is a multi-axis system where each power module can supply up to three servo motors. The base configuration consists of a common DC bus supply and multiples PSD1-M modules, connected through DC bus bars. The modules are available as one, two or three axis versions, this makes the system very flexible.

PSD1-M servo drive is particularly suitable for all centralised automation systems, such as those found in many packaging machines, where large numbers of drives are often required offering significant advantages.



SME: Brushless servo motors



The Single Cable Servo Drive System from Parker is based on the Hiperface DSL® digital feedback technology. The encoder feedback communication is fully integrated into the motor power cable and thus no separate feedback cable between drive and motor is required.

The feedback system is a purely digital encoder communication protocol with exceptional performance. The absolute position determination, a resolution of up to 20 bit per turn, as well as 4096 maximum rotations, is unique in its class. The System is a bespoke solution to provide machine builders with lower cabling and installation cost and the possibility to reduce control panel size and machine footprint. The SME Series is available in sizes from 0.5 to 60 Nm.

Interact Xpress: HMI

Interact Xpress is Parker's HMI hardware and software solution, for the process's control in distributed applications where multiple HMIs are deployed on a single machine or across several remote stations. Interact Xpress software, features an advanced development environment for easy creation of rich graphics and multimedia applications. Interact Xpress allows you to run, view and edit on line - from any PC - applications in Internet Explorer™ browser. Available with 6, 8, 10 and 15 inch, these units are specifically designed to optimize the performance, storage and connectivity features of the software.



Handling actuators

All linear actuators offered by Parker Hannifin feature a modular and therefore flexible structure. They reflect Parker's long practical experience in the field of handling technology. In addition, we have developed special solutions for various applications, such as actuators suitable for clean-room applications as well as actuators for the food industry. The mechanical components can be combined to create multi-axis systems with the aid of a range of attachments and accessories. The user can choose between different versions including linear, vertical and telescopic actuators as well as electric cylinders. In addition, several different drive technologies are available including ballscrews, toothed belt drive, linear motor and a combination of toothed belt and toothed rack.



ETT - Electric tubular motor

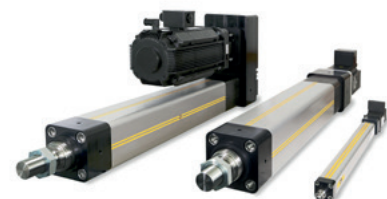

ETH - High Force Electro Thrust Cylinder

Order Code

Parker Automation Controller

	1		2	3	4	5	6		7	8
Order example	PAC320	-	M	W	N	2	1	-	3	A

1 Series

PAC320 Controller

2 Software

C IEC, PLCopen Motion, CNC

M IEC, PLCopen Motion

P IEC only

3 Visualization

X Xpress Visualization

W Web Visualization

4 Communications Options

N EtherCAT Protocol (standard)

E EtherCAT + Ethernet/IP Protocol

P EtherCAT + PROFINET Slave

B EtherCAT + Ethernet/IP + PROFINET

5 Retentive Memory

2 256k Bytes

6 Processor

1 1.60 GHz Dual Core Intel® N2600

7 Agency Approvals

3 UL/cUL/CE

8 Reserved

A Reserved



Parker's Motion & Control Technologies

At Parker, we're guided by a relentless drive to help our customers become more productive and achieve higher levels of profitability by engineering the best systems for their requirements. It means looking at customer applications from many angles to find new ways to create value. Whatever the motion and control technology need, Parker has the experience, breadth of product and global reach to consistently deliver. No company knows more about motion and control technology than Parker. For further info call 00800 27 27 5374



Aerospace

Key Markets

Aftermarket services
Commercial transports
Engines
General & business aviation
Helicopters
Launch vehicles
Military aircraft
Missiles
Power generation
Regional transports
Unmanned aerial vehicles

Key Products

Control systems & actuation products
Engine systems & components
Fluid conveyance systems & components
Fluid metering, delivery & atomization devices
Fuel systems & components
Fuel tank inerting systems
Hydraulic systems & components
Thermal management
Wheels & brakes



Climate Control

Key Markets

Agriculture
Air conditioning
Construction Machinery
Food & beverage
Industrial machinery
Life sciences
Oil & gas
Precision cooling
Process
Refrigeration
Transportation

Key Products

Accumulators
Advanced actuators
CO₂ controls
Electronic controllers
Filter driers
Hand shut-off valves
Heat exchangers
Hose & fittings
Pressure regulating valves
Refrigerant distributors
Safety relief valves
Smart pumps
Solenoid valves
Thermostatic expansion valves



Electromechanical

Key Markets

Aerospace
Factory automation
Life science & medical
Machine tools
Packaging machinery
Paper machinery
Plastics machinery & converting
Primary metals
Semiconductor & electronics
Textile
Wire & cable

Key Products

AC/DC drives & systems
Electric actuators, gantry robots & slides
Electrohydraulic actuation systems
Electromechanical actuation systems
Human machine interface
Linear motors
Stepper motors, servo motors, drives & controls
Structural extrusions



Filtration

Key Markets

Aerospace
Food & beverage
Industrial plant & equipment
Life sciences
Marine
Mobile equipment
Oil & gas
Power generation & renewable energy
Process
Transportation
Water Purification

Key Products

Analytical gas generators
Compressed air filters & dryers
Engine air, coolant, fuel & oil filtration systems
Fluid condition monitoring systems
Hydraulic & lubrication filters
Hydrogen, nitrogen & zero air generators
Instrumentation filters
Membrane & fiber filters
Microfiltration
Sterile air filtration
Water desalination & purification filters & systems



Fluid & Gas Handling

Key Markets

Aerial lift
Agriculture
Bulk chemical handling
Construction machinery
Food & beverage
Fuel & gas delivery
Industrial machinery
Life sciences
Marine
Mining
Mobile
Oil & gas
Renewable energy
Transportation

Key Products

Check valves
Connectors for low pressure fluid conveyance
Deep sea umbilicals
Diagnostic equipment
Hose couplings
Industrial hose
Mooring systems & power cables
PTFE hose & tubing
Quick couplings
Rubber & thermoplastic hose
Tube fittings & adapters
Tubing & plastic fittings



Hydraulics

Key Markets

Aerial lift
Agriculture
Alternative energy
Construction machinery
Forestry
Industrial machinery
Machine tools
Marine
Material handling
Mining
Oil & gas
Power generation
Refuse vehicles
Renewable energy
Truck hydraulics
Turf equipment

Key Products

Accumulators
Cartridge valves
Electrohydraulic actuators
Human machine interfaces
Hybrid drives
Hydraulic cylinders
Hydraulic motors & pumps
Hydraulic systems
Hydraulic valves & controls
Hydrostatic steering
Integrated hydraulic circuits
Power take-offs
Power units
Rotary actuators
Sensors



Pneumatics

Key Markets

Aerospace
Conveyor & material handling
Factory automation
Life science & medical
Machine tools
Packaging machinery
Transportation & automotive

Key Products

Air preparation
Brass fittings & valves
Manifolds
Pneumatic accessories
Pneumatic actuators & grippers
Pneumatic valves & controls
Quick disconnects
Rotary actuators
Rubber & thermoplastic hose & couplings
Structural extrusions
Thermoplastic tubing & fittings
Vacuum generators, cups & sensors



Process Control

Key Markets

Alternative fuels
Biopharmaceuticals
Chemical & refining
Food & beverage
Marine & shipbuilding
Medical & dental
Microelectronics
Nuclear Power
Offshore oil exploration
Oil & gas
Pharmaceuticals
Power generation
Pulp & paper
Steel
Water/wastewater

Key Products

Analytical Instruments
Analytical sample conditioning products & systems
Chemical injection fittings & valves
Fluoropolymer chemical delivery fittings, valves & pumps
High purity gas delivery fittings, valves, regulators & digital flow controllers
Industrial mass flow meters/controllers
Permanent no-weld tube fittings
Precision industrial regulators & flow controllers
Process control double block & bleeds
Process control fittings, valves, regulators & manifold valves



Sealing & Shielding

Key Markets

Aerospace
Chemical processing
Consumer
Fluid power
General Industrial
Information technology
Life sciences
Microelectronics
Military
Oil & gas
Power generation
Renewable energy
Telecommunications
Transportation

Key Products

Dynamic seals
Elastomeric o-rings
Electro-medical instrument design & assembly
EMI shielding
Extruded & precision-cut, fabricated elastomeric seals
High temperature metal seals
Homogeneous & inserted elastomeric shapes
Medical device fabrication & assembly
Metal & plastic retained composite seals
Shielded optical windows
Silicone tubing & extrusions
Thermal management
Vibration dampening

Parker Worldwide

Europe, Middle East, Africa

AE – United Arab Emirates, Dubai
Tel: +971 4 8127100
parker.me@parker.com

AT – Austria, Wiener Neustadt
Tel: +43 (0)2622 23501-0
parker.austria@parker.com

AT – Eastern Europe, Wiener Neustadt
Tel: +43 (0)2622 23501 900
parker.easteurope@parker.com

AZ – Azerbaijan, Baku
Tel: +994 50 2233 458
parker.azerbaijan@parker.com

BE/LU – Belgium, Nivelles
Tel: +32 (0)67 280 900
parker.belgium@parker.com

BG – Bulgaria, Sofia
Tel: +359 2 980 1344
parker.bulgaria@parker.com

BY – Belarus, Minsk
Tel: +375 17 209 9399
parker.belarus@parker.com

CH – Switzerland, Etoy
Tel: +41 (0)21 821 87 00
parker.switzerland@parker.com

CZ – Czech Republic, Klecany
Tel: +420 284 083 111
parker.czechrepublic@parker.com

DE – Germany, Kaarst
Tel: +49 (0)2131 4016 0
parker.germany@parker.com

DK – Denmark, Ballerup
Tel: +45 43 56 04 00
parker.denmark@parker.com

ES – Spain, Madrid
Tel: +34 902 330 001
parker.spain@parker.com

FI – Finland, Vantaa
Tel: +358 (0)20 753 2500
parker.finland@parker.com

FR – France, Contamine s/Arve
Tel: +33 (0)4 50 25 80 25
parker.france@parker.com

GR – Greece, Athens
Tel: +30 210 933 6450
parker.greece@parker.com

HU – Hungary, Budaörs
Tel: +36 23 885 470
parker.hungary@parker.com

IE – Ireland, Dublin
Tel: +353 (0)1 466 6370
parker.ireland@parker.com

IT – Italy, Corsico (MI)
Tel: +39 02 45 19 21
parker.italy@parker.com

KZ – Kazakhstan, Almaty
Tel: +7 7273 561 000
parker.easteurope@parker.com

NL – The Netherlands, Oldenzaal
Tel: +31 (0)541 585 000
parker.nl@parker.com

NO – Norway, Asker
Tel: +47 66 75 34 00
parker.norway@parker.com

PL – Poland, Warsaw
Tel: +48 (0)22 573 24 00
parker.poland@parker.com

PT – Portugal, Leca da Palmeira
Tel: +351 22 999 7360
parker.portugal@parker.com

RO – Romania, Bucharest
Tel: +40 21 252 1382
parker.romania@parker.com

RU – Russia, Moscow
Tel: +7 495 645-2156
parker.russia@parker.com

SE – Sweden, Spånga
Tel: +46 (0)8 59 79 50 00
parker.sweden@parker.com

SK – Slovakia, Banská Bystrica
Tel: +421 484 162 252
parker.slovakia@parker.com

SL – Slovenia, Novo Mesto
Tel: +386 7 337 6650
parker.slovenia@parker.com

TR – Turkey, Istanbul
Tel: +90 216 4997081
parker.turkey@parker.com

UA – Ukraine, Kiev
Tel: +380 44 494 2731
parker.ukraine@parker.com

UK – United Kingdom, Warwick
Tel: +44 (0)1926 317 878
parker.uk@parker.com

ZA – South Africa, Kempton Park
Tel: +27 (0)11 961 0700
parker.southafrica@parker.com

North America

CA – Canada, Milton, Ontario
Tel: +1 905 693 3000

US – USA, Cleveland
Tel: +1 216 896 3000

Asia Pacific

AU – Australia, Castle Hill
Tel: +61 (0)2-9634 7777

CN – China, Shanghai
Tel: +86 21 2899 5000

HK – Hong Kong
Tel: +852 2428 8008

IN – India, Mumbai
Tel: +91 22 6513 7081-85

JP – Japan, Tokyo
Tel: +81 (0)3 6408 3901

KR – South Korea, Seoul
Tel: +82 2 559 0400

MY – Malaysia, Shah Alam
Tel: +60 3 7849 0800

NZ – New Zealand, Mt Wellington
Tel: +64 9 574 1744

SG – Singapore
Tel: +65 6887 6300

TH – Thailand, Bangkok
Tel: +662 186 7000

TW – Taiwan, Taipei
Tel: +886 2 2298 8987

South America

AR – Argentina, Buenos Aires
Tel: +54 3327 44 4129

BR – Brazil, Sao Jose dos Campos
Tel: +55 800 727 5374

CL – Chile, Santiago
Tel: +56 2 623 1216

MX – Mexico, Toluca
Tel: +52 72 2275 4200



EMEA Product Information Centre

Free phone: 00 800 27 27 5374

(from AT, BE, CH, CZ, DE, DK, EE, ES, FI, FR, IE, IL, IS, IT, LU, MT, NL, NO, PL, PT, RU, SE, SK, UK, ZA)

US Product Information Centre

Toll-free number: 1-800-27 27 537

www.parker.com